

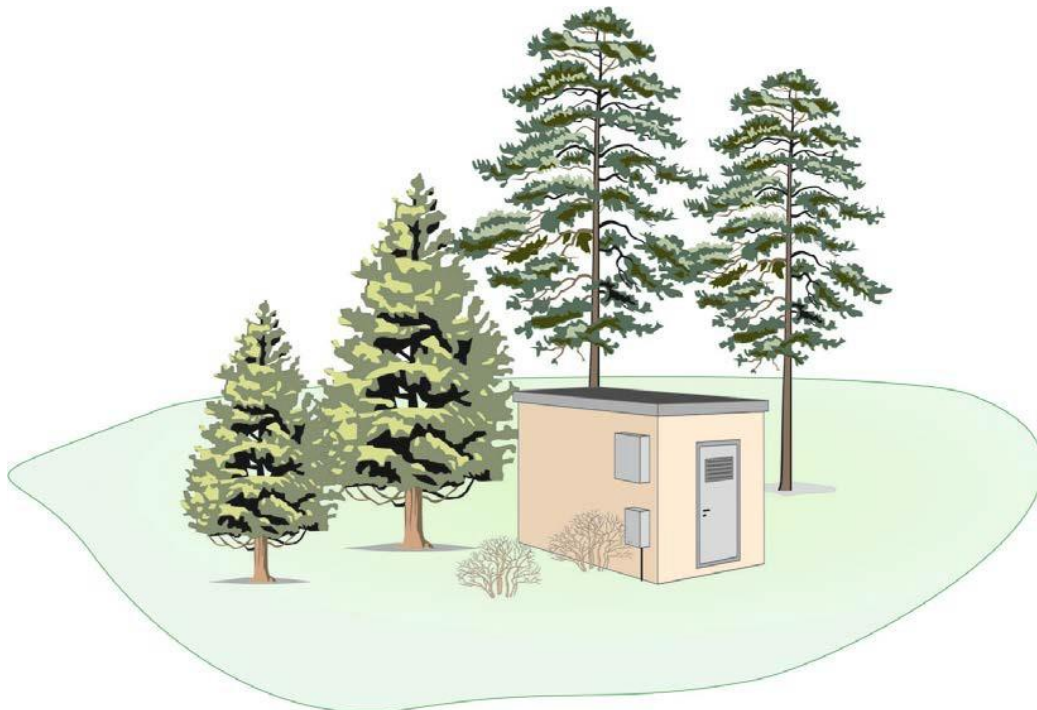

# Instructions for Robust Fiber

## Appendix 4 Robust sites and nodes

Ver 1.3.1



## CONTENTS

<b>1.</b>	<b>Introduction .....</b>	<b>3</b>
<b>2.</b>	<b>Sites and nodes.....</b>	<b>4</b>
	2.1 Classification of sites and nodes.....	4
	2.2 Establishing sites and nodes .....	5
	2.2.1 Location.....	5
	2.2.2 Building consents and permits.....	6
	2.2.3 Type of site or node .....	6
	2.2.4 Design of sites and nodes.....	8
	2.2.5 Electrical installation.....	11
	2.2.6 Electrical safety.....	11
	2.2.7 Environment and climate regulation .....	12
	2.2.8 Dust, dirt and moisture.....	13
	2.2.9 Safety (mechanical protection) .....	14
	2.2.10 Alarms .....	15
	2.2.11 Biological damage.....	16
	2.2.12 Fire protection.....	16
	2.2.13 Maintenance plan .....	17
	2.2.14 Other .....	17
	2.2.15 Compilation of requirements and recommendations for sites and nodes.....	18

## 1. INTRODUCTION

The document "*Instructions for Robust Fiber*" comprises one main document and a number of appendices.

This appendix, Robust sites and nodes, contains minimum requirements regarding how a robust site or node should be installed. The appendix also contains recommendations and examples of the possible appearance both outdoors and indoors.

The appendix begins with the classification of sites and nodes based on the Operational reliability regulations, before going through various requirements and recommendations that apply to robust sites and nodes.

Minimum requirements within the following areas are defined in the appendix.

- Location
- Building consents and permits
- Type of site and node
- Design of sites and nodes
- Electricity supply
- Electrical safety
- Environment and climate regulation
- Dust, dirt and moisture
- Safety (mechanical protection)
- Alarms
- Biological damage
- Fire protection
- Maintenance plan
- Signs

## 2. SITES AND NODES

To gain a good understanding of the content of this chapter, it is good to know the difference between a site and a node.

### Site

Site refers to the physical space. For example, this might be a technical shelter, an outdoor cabinet, one/more buildings or a room.

Sites incorporate e.g. the following functions:

- Shell protection.
- Electrical system.
- Auxiliary power system.
- Climate system.

### Node

Node refers to a distribution point (connection point) where traffic flows are forwarded, concentrated and/or distributed. A node is located in a site.

The node has e.g. the following components:

- ODF rack.
- ODF units.
- Patch (connecting) cables.
- Active communication equipment (routers, switches, etc.).

### 2.1 Classification of sites and nodes

In order to read more about requirements that apply to the classification of sites and nodes with the aim of achieving operational reliability for a fibre installation, in line with the relevant ordinance, please refer to PTS's operational reliability regulations.

A management model for operational reliability, with templates showing how the network owner can handle operational reliability, can be found at the Swedish Local Fibre Alliance, [www.ssnf.org](http://www.ssnf.org).

When establishing a new site or node, it is important to first conduct a risk analysis according to that specified in the Operational reliability regulations and the customer requirements. With this as a starting point, the site and/or node must be adapted so that it corresponds to the anticipated requirements.

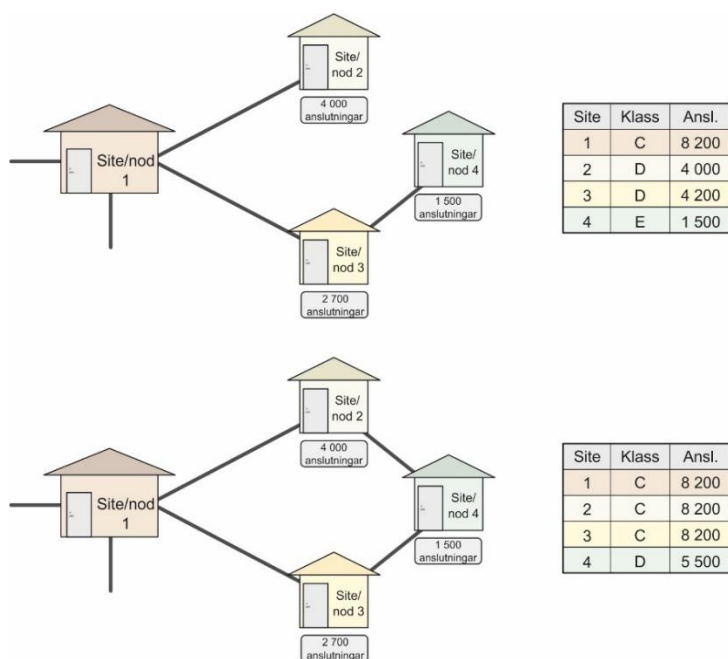

*Example of classification of nodes and sites*

## 2.2 Establishing sites and nodes

Below is a review of the areas with particular factors to take into consideration when establishing a new site or node.

### 2.2.1 Location

The location of the fibre installation's sites and nodes is determined during the planning phase.

#### Minimum requirements regarding location:

- Outdoor cabinets must be positioned in locations that are well protected from snow clearance operations.
- Sites must never be located close to watercourses or in dips where there is a risk of flooding.

#### Recommendations for location:

- In the first instance, locate the site in a building intended for telecommunications. This can be done by erecting a separate building or by placement with another network owner.
- Avoid placement in buildings for which another party is responsible and where the premises are not intended to be used for telecommunication. For this reason, placement in schools, homes for the elderly, club premises, etc., must be avoided as far as possible.
- Outdoor cabinets should in the first instance be placed in a shady location.
- Select a location where the cable distances are optimised for connection up to the node, from the end customer and to other nodes.
- Position the node where the option of several connection paths exists, with a view to redundancy Both for fibre optic cables and for the electricity mains.
- For fibre alliances, it is good to position the node where it is possible to connect to several network owners.

## 2.2.2 Building consents and permits

When a new site is to be established, local provisions and permits have to be managed.

### Minimum requirements in the case of establishment:

- Building consents are generally always required when establishing a new site.
- The land owner's consent (e.g. land agreements and easements for roads) must be obtained in order to position the site in the intended location.

Local provisions that may occur:

- Requirements regarding the appearance of the facade, choice of materials and colours.
- Requirements regarding noise levels (the site's climate system, the equipment's fans and auxiliary power systems can produce noise that is considered disturbing). Noise protection or requirements for a different location may be demanded.

## 2.2.3 Type of site or node

A site or node can be executed in various ways and in different forms. Below are a few examples.

### 2.2.3.1 Climate cabinet

Also known as an outdoor cabinet or environmental cabinet.

Climate cabinets are common in small networks and where few connections are terminated. They are less suitable for the placement of active equipment due to the lack of space, climate regulation and the work environment.

The installation depth for equipment in a cabinet is often critical, as the equipment may require a considerable depth, e.g. UPS.

### Minimum requirements regarding climate cabinet:

- The climate cabinet must have at least IP class 54.



*Example of outdoor cabinet*

### 2.2.3.2 Technical shelter

It is an advantage to select a technical shelter instead of a climate cabinet. The technical shelter provides more space and the potential to work indoors, which creates a better work environment during service and maintenance.

The technical shelter's appearance and function can be adapted according to the client's wishes. They are available in different sizes, from one rack location up to the required number. The technical shelter is well suited for all types of fibre installations and can be dimensioned so that other parties can be offered placement. They can be placed on a cast foundation or stand on plinths.



*Example of a technical shelter*

#### Minimum requirements regarding technical shelter

- The technical shelter must be designed for the Nordic climate (e.g. cope with snow loads, cold conditions and heat).

### 2.2.3.3 Utilise part of an existing building.

When utilising an existing building, an area can be adapted for the fibre installation in e.g. a cellar.

Enter into a clear agreement with the property owner regarding placement and electricity supply. Being forced to move a node requires a great deal of work and therefore constitutes a major expense. It is important therefore to take care regarding the agreement's terms and conditions as well as its duration.

#### Minimum requirements when using existing building:

- Ensure that access to the space is guaranteed 24 hours a day. Ideally with a separate door from the outside.

#### 2.2.3.4 Placement in another party's site

Site space can be hired from another network owner for placement of your own node. This could be in an existing telecommunications exchange, for example.

#### Minimum requirements for placement:

- Ensure there is access 24 hours a day and make sure that affected personnel have permission to be in the area.
- Enter into an agreement with the property owner regarding the supply of electricity, with the required output level, as well as ensuring that the correct climate is maintained.

#### 2.2.4 Design of sites and nodes

The site's fittings and physical space requirements are dependent on the amount of connections that are to be terminated, whether active equipment is to be placed there, and whether other parties are to be given the opportunity to place equipment in the space.

When designing the fittings, it is important to consider several things.

#### Minimum requirements for a site:

- A site must be dimensioned in order to handle auxiliary power systems based on customer requirements and the site's function in the network.
- A site must be equipped with a climate system.
- A site must have a non-return valve in the floor drain (where present).
- The site must have automatic shut-off of water pipes present in the space.

#### Minimum requirements for a node:

- A node must have sufficient space for racks that are dimensioned for the connections that may be terminated in the space
- A node must have sufficient space for the active communication equipment that will be placed in the space
- A node must be planned to ensure that mutual location of heat-generating equipment does not heat up other equipment, but rather that the heat is removed

#### Recommendations for fittings:

- Space for a work space is something that is often forgotten, but that makes service and maintenance work easier.
- Position equipment to optimise the area within the space.
- Position and design installation routes to ensure good order in the space and the potential for smooth service and maintenance work.
- Separate power and fibre optic cables in installation routes. Despite the fact that fibre optic cables are not affected by electricity, service and maintenance are made easier by separating the cables.
- There should not be any heating, water or sewage pipes passing through the space, in order to minimise the risk of water damage.



Examples of nodes:

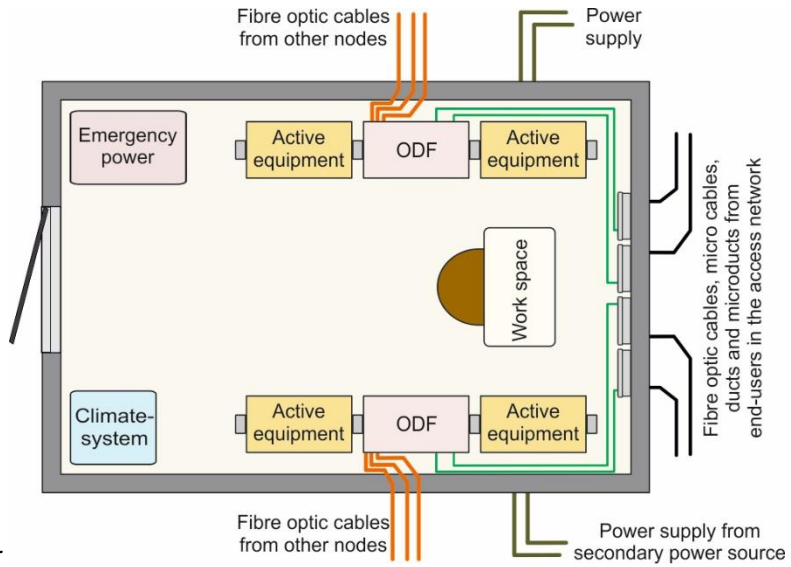

Example of a technical shelter

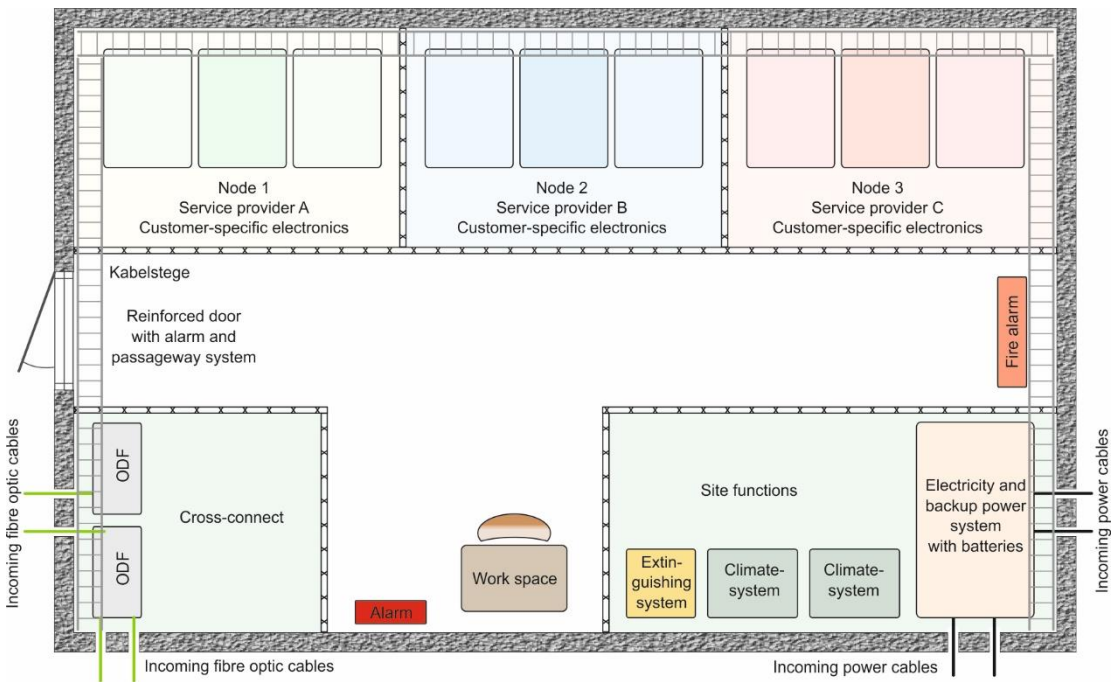

Example of larger site with several nodes

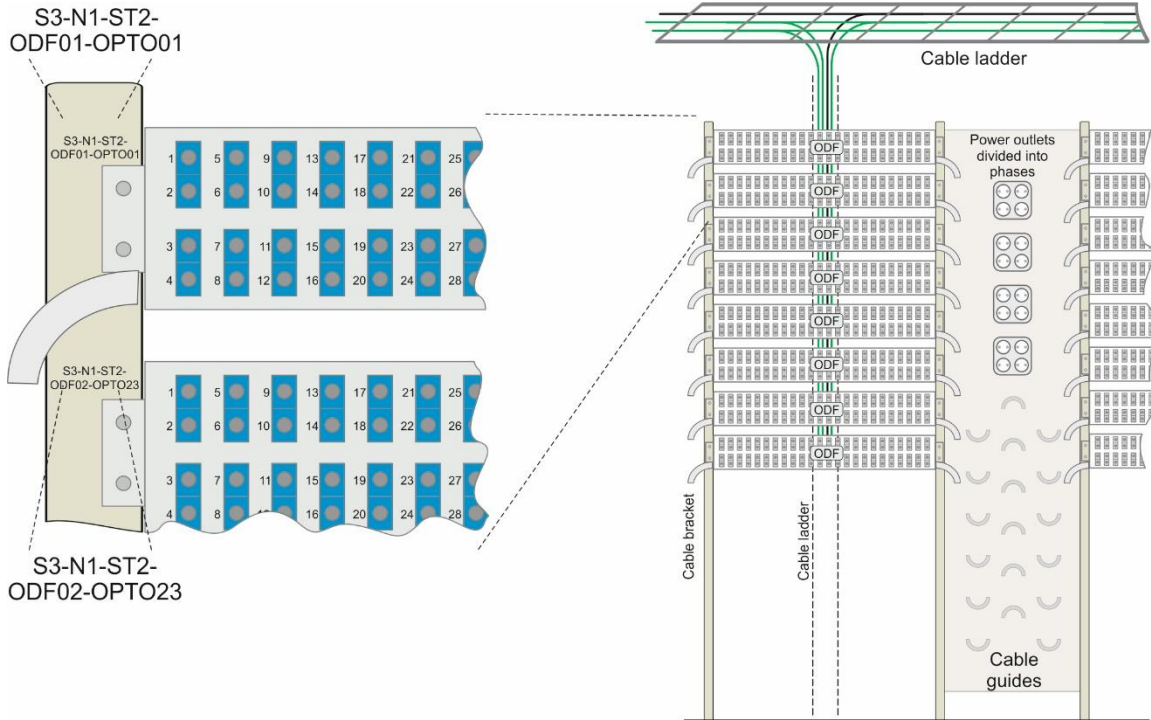

*Example of rack labelling*

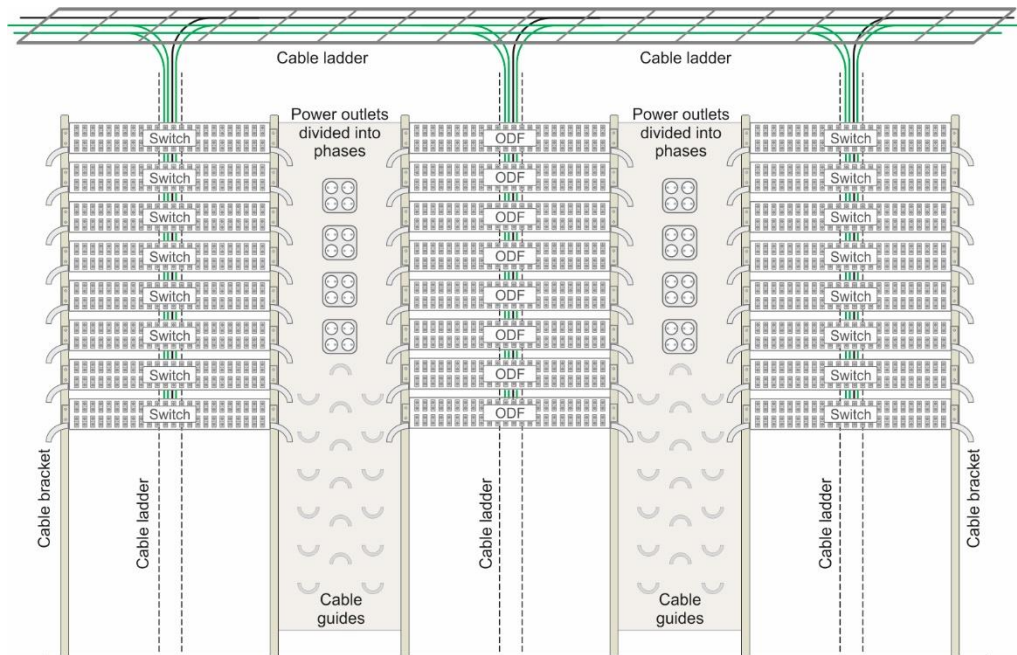

*Example of rack placement*

## 2.2.5 Electrical installation

The electrical installation in sites and nodes must be handled in accordance with applicable laws and regulations.

### 2.2.5.1 Electrical system

Depending on the site's function and classification, redundant connections to the electricity mains may be required.

#### Minimum requirements regarding electrical system:

- Distribution boards in the site must be adapted for 230/400 V as a TN-S system.
- Distribution boards must be grouped and fused for each group.
- Service outlets must be supplied with RCBOs.

#### Recommendations:

- At racks, electric outlets must be installed so that they are easily accessible and evenly distributed between three phases.
- In larger sites and nodes, the installation must be supplied with residual current devices.

### 2.2.5.2 Auxiliary power systems

Auxiliary power systems supply sites and nodes with electrical power in the event of interruptions in incoming electrical power supplies. This could e.g. be a generator that is powered by a motor (permanently installed or portable), a fuel cell or a UPS with batteries. An auxiliary power system must be present when stipulated by the Operational reliability regulations or customer requirements.

#### Minimum requirements regarding auxiliary power systems:

- Auxiliary power systems must be dimensioned for an operating time in accordance with requirements in the Operational reliability regulations or from connected customers.
- Where there is a UPS with batteries, the site must have an externally accessible intake for connecting the auxiliary power unit (emergency power generator).

#### Recommendations:

- In the event of racks, electric outlets from the auxiliary power system must be easily accessible and clearly labelled.
- Damage that may arise in conjunction with over-voltage and short interruptions can be countered through appropriate fusing and systems for equipotential bonding. A UPS is suitable for this.
- When connecting an emergency power generator, the incoming supply to the site should be a TN-C system. After the emergency power generator, the internal electrical system in the site is then converted to a TN-S system.

## 2.2.6 Electrical safety

### 2.2.6.1 Lightning protection

Disruption caused by lightning is common. It is therefore important to protect the site and the equipment placed there against disruption caused by lightning.

Avoid using ducts containing metal connected to nodes as these conduct current.

**Minimum requirements for lightning protection:**

- The site must be properly earthed.
- The site must be equipped with over-voltage protection and RCDs.

**2.2.6.2 Equipotential bonding**

Equipotential bonding is used to connect all conducting units to each other at a common point so that they thereby receive the same potential. This minimises problems in respect of earth currents, galvanic isolation, static electricity and improves lightning protection within the site.

**Minimum requirements for equipotential bonding:**

- All conducting parts are connected directly to the main equipotential bonding.
- The main equipotential bonding is connected to earth.
- All incoming conducting parts must be connected to the main equipotential bonding.

**2.2.6.3 EMC (electromagnetic compatibility)**

Electromagnetic radiation can arise in the vicinity of electrical installations, fan motors, lift motors, distribution boards, etc. If the equipment is poorly/incorrectly earthed, stray currents can occur that can give rise to interference.

**Minimum requirements for EMC:**

- Installed equipment must satisfy the applicable standard for CE marking according to the EU-EMC directive.

**2.2.7 Environment and climate regulation**

It is very important to keep the temperature and humidity at the correct level within the site. Heat damage can arise in electronic equipment if it is installed in an environment with a raised temperature. Cold damage can arise in the winter if equipment is located in areas that do not have sufficient heating, e.g. optical connectors and certain cables can be affected in cold conditions. Condensation can arise when the humidity is too high, while static electricity can arise when the humidity is too low. Below are examples of climate systems.

**Heating element**

In certain cases, a heating element may be sufficient. Applies primarily in areas with a low ambient temperature.

**Fan**

Temperature-controlled fan for the removal of surplus heat or blowing in of cold outside air.

## Free cooling

Free cooling uses colder ambient air for cooling. Fans force in cold air, through filters, producing overpressure in the site. Warm air is evacuated at the opposite end of the site. Free cooling is a good choice when the ambient temperature is normally lower than the temperature in the site, and ensures low energy consumption during normal operation. Free cooling can be supplemented with another cooling unit for occasions when the ambient temperature is high.



*Example of free cooling unit*

## Air heating pump

Works both as a heating and cooling unit, providing an even climate all year around.

### Minimum requirements for climate regulation:

- A climate system must be present so that temperature and humidity are kept within the limit values that apply to the equipment placed in the node.
- A cooling system must be located so that leaks of liquid or condensation cannot reach the installed equipment.
- Drainage from the cooling system must be led out of the area.

Recommendations for climate systems:

- Select a climate system that can be controlled and monitored remotely.
- Dimension the auxiliary power system for the climate system as well, or ensure in some other way that the climate can be maintained at the correct level for a limited period.
- Plan for the potential for an emergency cooling system or bear in mind the need for a redundant climate system.

### 2.2.8 Dust, dirt and moisture

Dust, other dirt and moisture can damage active equipment in the site and make the connection of optical connectors difficult. Dust can also cause heating problems, as dust particles in the fans gradually impair air circulation over time, resulting in overheating of the active equipment.

### Minimum requirements for filters:

- Filters must be installed in all valves and supply air routes. Filters that are at least EU3 classified are recommended.

Water damage can arise as a result of e.g. flooding, damaged equipment or carelessness. Moisture can cause damage and disruptions to active equipment, electrical cables and connectors (optical and electrical).

#### Minimum requirements for moisture protection:

- A site or node in a building must be fitted with raised thresholds where there is a risk of flooding.

#### 2.2.9 Safety (mechanical protection)

The shell protection for a fibre installation is important. Installations can be protected to some extent through locks and alarms. The choice of cable routes and their protection are also important. The safety measures you implement will in practice be a matter of weighing up between the current threat situation, the significance of the site and the cost of implementing safety measures. The safety issues are also important when insuring the installation.

Recommendations for safety:

- In a site where space has been granted to another party, it is recommended that the site owner's own equipment (power supply, climate system, etc.) and nodes (communication equipment, ODF units, etc.) be located separately from equipment that is owned by the other party that is hiring space from the site owner.
- Parties that hire space for the placement of their own equipment cabinets or that hire space for placing equipment in equipment cabinets that are owned by the site owner, are themselves responsible for the protection of their own cross-connection points and equipment.

##### 2.2.9.1 Burglar protection

Mechanical burglar protection refers to physical/mechanical measures that are implemented to prevent burglaries in node spaces.

#### Minimum requirements for burglar protection

- Doors to the area with direct access from outside must be made of steel.
- Doors in the existing building must be secured with e.g. a bolt, trailing edge strengthening device or equivalent protection.
- Only personnel authorised by the site owner may have access to the area.
- Keys must not be stored in the area.

You can find out more about burglar protection from the Swedish Theft Prevention Association.

### 2.2.9.2 Sabotage protection

Sabotage protection refers to the measures that are implemented to impede or prevent sabotage to the fibre installation. Where there is a risk that incoming cables might be subjected to sabotage or other external effects, the cables must be supplied with a protective arrangement that impedes or prevents this.

#### Minimum requirements for sabotage protection:

- Accessible cables must be protected against sabotage.
- For sites that do not have a cast foundation, the protection between the ground and the underside of the floor must be designed so that it covers at least three sides around incoming cables. The protection must be buried at a depth of at least 25 cm and must be anchored in the floor. It may be executed as a robust protective pipe, a steel plate (at least 1.5 mm) that covers at least three sides of the ducts, or other equivalent protection.
- If possible, towing and lifting eyelets must be removed from technical shelters or climate cabinets.
- Shelters or containers must be securely anchored to the ground, e.g. through properly buried plinths or concrete beams.

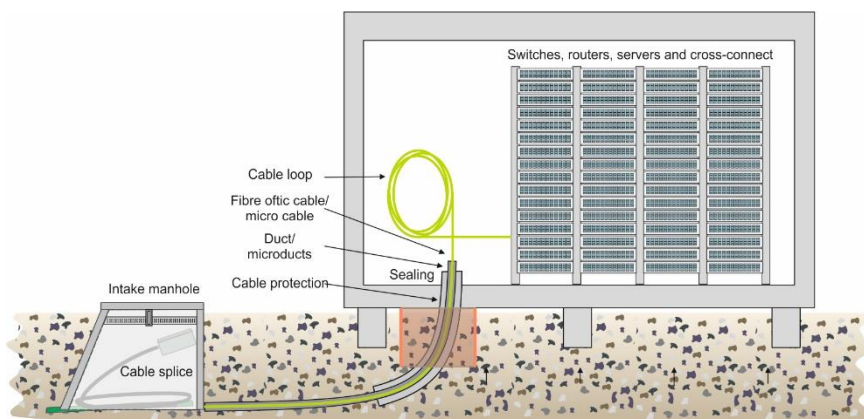

Example of cable intake

### 2.2.10 Alarms

Alarms refer to specific functions for obtaining information about the status of the site.

#### 2.2.10.1 Burglar alarm

The purpose of a burglar alarm is to increase the security of monitored buildings.

#### Minimum requirements if a burglar alarm is present:

- Alarms must be transmitted to the operations centre and/or a surveillance company.

Recommendation regarding burglar alarm:

- In the event a burglar alarm is tripped, a buzzer signal should sound as a preliminary warning before the alarm siren is engaged (approx. 30 seconds).

The burglar alarm can be extended with an assault alarm to increase personal safety.

### 2.2.10.2 Operation alarm

An operation alarm refers to a function for receiving alarms from equipment in the site.

Examples of functions that can be monitored via an operation alarm:

- Climate (temperature, humidity).
- Water (moisture and flooding).
- Incoming power supply (power failure).
- Auxiliary power system (battery status).
- Entry alarm (unlocked door).
- Climate system (temperature, humidity).

#### Minimum requirements for operation alarm:

- There must be a function for receiving operation alarms.

As regards requirements for monitoring communication services, see the Operational reliability regulations.

### 2.2.10.3 Access control

Access control systems are a good way for the site's owner to see which individuals have been on the site. For personal safety, it is also good to know that a person is or has been on the site. This also provides the potential to follow up faults or defective installations.

Examples of access control systems include:

- Signed out key.
- System with cards or tags.
- System with dialled code.

### 2.2.11 Biological damage

Biological damage refers to damage that can arise due to pests (e.g. rodents, ants or insects). A good form of protection against insect attacks is to install filter devices at the site's ventilation openings.

#### Minimum requirements for protection against biological damage:

- Where fibre optic cables or ducts are exposed to pests, such as rodent attacks, they must be protected with rodent protection, e.g. by means of additional metal reinforcement or pipes and fibre optic cables treated with repellent.
- Ducts must be sealed so that pests cannot travel through them.

### 2.2.12 Fire protection

Boverket's building regulations (BBR) handle regulations relating to fire protection. The level of the site's fire protection is determined by the risk analysis that is performed in conjunction with the establishment of the site. Also consult with the insurance company regarding which fire protection will apply and whether fire alarms are required.

#### Minimum requirements regarding fire protection:

- The site's surrounding surface (e.g. walls, floor, roof, doors and windows) must satisfy fire class EI 30 on both sides as a minimum.
- Cell plastic should not be used as insulation in a Site



**Recommendation regarding fire alarm:**

- In order to avoid the site being disabled by means of e.g. corrosive gases or water vapour penetrating the site due to a fire in the surroundings, the site should be built as a sealed unit with the exception of the ventilation system.

**2.2.12.1 Fire extinguishing equipment****Minimum requirements regarding fire extinguishing equipment:**

- Personnel who work in the site or node must have access to hand-held CO<sub>2</sub> extinguishers of at least 5 kg in the premises.
- When there are premises or a building for an emergency power generator, this area must be supplied with powder extinguishers.

You can read more about fire protection and extinguishing equipment at the Swedish Fire Protection Association.

**2.2.13 Maintenance plan**

Some equipment requires recurring maintenance. For this reason, a maintenance plan must be drawn up containing a list of the maintenance that has to be carried out and when it has to be done.

The Operational reliability regulations specify that structured work on operational reliability must be conducted in the long term, continually and systematically.

**Minimum requirements for a maintenance plan:**

- Sites and nodes must have a maintenance plan.
- In addition to that specified in the Operational reliability regulations, the maintenance plan must include regular inspection of filters, climate systems, electrical systems, locks and access control systems according to the manufacturer's instructions and, if necessary, clearance of snow, brushwood and grass.

**2.2.14 Other**

The presence of signs outside the site must be limited so that interest in the site or node is kept to a minimum. However, there should be a sign giving telephone numbers that the public can call if they notice that something or someone is acting unusually at the site.

**Minimum requirements for signs:**

There should not be any signs specifying the site's owner etc.

## 2.2.15 Compilation of requirements and recommendations for sites and nodes

Compilation of requirements and recommendations for sites and nodes					
X MINIMUM REQUIREMENTS R RECOMMENDATIONS • Action based on risk analysis and customer requirements	SITE/NODE CLASS				
	A	B	C	D	E
2.2.3 Type of site					
Outdoor cabinet (Climate cabinet, Environmental cabinet)				X	X
Technical shelter	X	X	X	X	X
Building (technical premises)	X	X	X	X	X
2.2.2 Building consents and permits					
Building consents are generally always required when establishing a new site.	X	X	X	X	X
The land owner's consent (e.g. land agreements for roads) must be obtained in order to position the site in the intended location.	X	X	X	X	X
2.2.1 Location of Site					
Outdoor cabinets must be positioned in locations that are well protected from snow clearance operations.				X	X
Sites must never be located close to watercourses or in dips where there is a risk of flooding.	X	X	X	X	X
Outdoor cabinets should in the first instance be placed in a shady location.				R	R
2.2.1 Location of Node					
In the first instance, locate the node site in a separate building intended for telecommunications.	X	X	R	R	R
Select a location where the cable distances are optimised for connection up to the node, from the end customer and to other nodes.	R	R	R	R	R
Position the node where the option of several connection paths exists, with a view to redundancy Both for fibre optic cables and for the electricity mains.	R	R	R	R	R
For fibre alliances, it is good to position the node where it is possible to connect to several network owners.	R	R	R	R	R
2.2.3.1 Climate cabinet					
The climate cabinet must have at least IP class 54.				X	X
2.2.3.2 Technical shelter					
The technical shelter must be designed for the Nordic climate (e.g. cope with snow loads, cold conditions and heat)	X	X	X	X	X
2.2.3.3 Existing building (technical premises)					
Adapt a space for the fibre installation	X	X	X	X	X
Ensure that access to the space is guaranteed 24 hours a day. With a separate door from the outside.	X	X	X	X	X
2.2.3.4 Placement of node in another party's site					
Ensure there is access 24 hours a day and make sure that affected personnel have permission to be in the area.			X	X	X

Enter into an agreement with the property owner regarding the supply of electricity, with the required output level, as well as ensuring that the correct climate is maintained.			X	X	X
<b>2.2.4 Design of site</b>					
A site must be dimensioned in order to handle auxiliary power systems based on customer requirements and the site's function in the network.	X	X	X	X	X*
A site must be equipped with a climate system.	X	X	X	X	X*
A site must have a non-return valve in the floor drain (where present).	X	X	X	X	X
The site must have automatic shut-off of water pipes present in the space.	X	X	X	X	X
Space for a work <b>space</b> is something that is often forgotten, but that makes service and maintenance work easier.	R	R	R	R	R
Position equipment to optimise the area within the space.	R	R	R	R	R
Position and design installation routes to ensure good order in the space and the potential for smooth service and maintenance work.	R	R	R	R	R
Separate power and fibre optic cables in installation routes. Despite the fact that fibre optic cables are not affected by electricity, service and maintenance are made easier by separating the cables.	R	R	R	R	R
There should not be any heating, water or sewage pipes passing through the space, in order to minimise the risk of water damage.	R	R	R	R	R
<b>2.2.4 Design of node</b>					
A node must have sufficient space for racks that are dimensioned for the connections that may be terminated in the space	X	X	X	X	X
A node must have sufficient space for the active communication equipment that will be placed in the space	X	X	X	X	X
A node must be planned to ensure that mutual location of heat-generating equipment does not heat up other equipment, but rather that the heat is removed	X	X	X	X	X
<b>2.2.5.1 Electrical system</b>					
Distribution boards in the site are adapted for 230/400V as a TN-S system and supplied with residual current devices	X	X	X	X	X
The site must be fitted with residual current devices	X	X	R		
Distribution boards must be grouped and fused for each group.	X	X	X	X	X
Service outlets must be supplied with RCBOs.	X	X	X	X	X
At racks, electric outlets must be installed so that they are easily accessible and evenly distributed between three phases.	R	R	R	R	R
<b>2.2.5.2 Auxiliary power system</b>					
Auxiliary power systems must be dimensioned for an operating time in accordance with requirements in the Operational reliability regulations or from connected customers.	X	X	X	X	X*
Where there is a UPS with batteries, the site must have an externally accessible outlet for connecting the auxiliary power unit (emergency power generator).	X	X	X	X	X*
In the event of racks, electric outlets from the auxiliary power system must be easily accessible and clearly labelled.	R	R	R	R	R
Damage that may arise in conjunction with over-voltage and short interruptions can be countered through appropriate fusing and systems for equipotential bonding. A UPS is suitable for this.	R	R	R	R	R
When connecting an emergency power generator, the incoming supply to the site should be a TN-C system. After the emergency power	R	R	R	R	R

generator, the internal electrical system in the site is then converted to a TN-S system.					
<b>2.2.6.1 Lightning protection</b>					
The site must be properly earthed.	X	X	X	X	X
The site must be equipped with over-voltage protection and RCDs.	X	X	X	X	X
<b>2.2.6.2 Equipotential bonding</b>					
All conducting parts are connected directly to the main equipotential bonding.	X	X	X	X	X
The main equipotential bonding is connected to earth.	X	X	X	X	X
All incoming conducting parts must be connected to the main equipotential bonding.	X	X	X	X	X
<b>2.2.6.3 EMC</b>					
Installed equipment must satisfy the applicable standard for CE marking according to the EU-EMC directive.	X	X	X	X	X
<b>2.2.7 Environment and climate regulation</b>					
A climate system must be present so that temperature and humidity are kept within the limit values that apply to the equipment placed in the node.	X	X	X	X	X
A cooling system must be located so that leaks of liquid or condensation cannot reach the installed equipment.	X	X	X	X	X
Drainage from the cooling system must be led out of the area.	X	X	X	X	X
Select a climate system that can be controlled and monitored remotely.	X	X	X	R	R
Dimension the auxiliary power system for the climate system as well, or ensure in some other way that the climate can be maintained at the correct level for a limited period.	X	X	X	X	X
Plan for the potential for an emergency cooling system or bear in mind the need for a redundant climate system.	X	X	X		
<b>2.2.8 Dust, moisture and dirt</b>					
Filters: Filters must be installed in all valves and supply air routes. Filters that are at least EU3 classified are recommended.	X	X	X	X	X
Moisture protection: A site or node in a building must be fitted with raised thresholds where there is a risk of flooding.	X	X	X	X	X
<b>2.2.9 Safety</b>					
In a site where space has been granted to another party, it is recommended that the site owner's own equipment (power supply, climate system, etc.) and nodes (communication equipment, ODF units, etc.) be located separately from equipment that is owned by the other party that is hiring space from the site owner.	X	X	X		
Parties that hire space for the placement of their own equipment cabinets or that hire space for placing equipment in equipment cabinets that are owned by the site owner, are themselves responsible for the protection of their own cross-connection points and equipment.	X	X	X	X	X
<b>2.2.9.1 Burglar protection</b>					
Doors to the area with direct access from outside must be made of steel.	X	X	X		
Doors in the existing building must be secured with e.g. a bolt, trailing edge strengthening device or equivalent protection.	X	X	X		
Only personnel authorised by the site owner may have access to the area.	X	X	X	X	X
Keys must not be stored in the area.	X	X	X	X	X
<b>2.2.9.2 Sabotage protection</b>					
Accessible cables must be protected against sabotage.	X	X	X	X	X

For sites that do not have a cast foundation, the protection between the ground and the underside of the floor must be designed so that it covers at least three sides around incoming cables. The protection must be buried at a depth of at least 25 cm and must be anchored in the floor. It may be executed as a robust protective pipe, a steel plate (at least 1.5 mm) that covers at least three sides of the ducts, or other equivalent protection.	X	X	X	X	X
If possible, towing and lifting eyelets must be removed from technical shelters or climate cabinets.			X	X	X
Shelters or containers must be securely anchored to the ground, e.g. through properly buried plinths or concrete beams.			X	X	X
<b>2.2.10.1 Burglar alarm</b>					
Alarms must be transmitted to the operations centre and/or a surveillance company.	X	X	R	R	
In the event a burglar alarm is tripped, a buzzer signal should sound as a preliminary warning before the alarm siren is engaged (approx. 30 seconds).	X	X	R	R	
<b>2.2.10.2 Operation alarm</b>	X	X	X	X	X
There must be a function for receiving operation alarms.	X	X	X	X	X
<b>2.2.10.3 Access control</b>	X	X	X	X	X
<b>2.2.11 Biological damage</b>					
Where fibre optic cables or ducts are exposed to pests, such as rodent attacks, they must be protected with rodent protection, e.g. by means of additional metal reinforcement or pipes and fibre optic cables treated with repellent.	X	X	X	X	X
Ducts must be sealed so that rodents cannot travel through them.	X	X	X	X	X
<b>2.2.12 Fire protection</b>					
The site must satisfy fire class EI 30 as a minimum.	X	X	X	X*	X*
In order to avoid the site being disabled by means of e.g. corrosive gases or water vapour penetrating the site due to a fire in the surroundings, the site should be built as a sealed unit with the exception of the ventilation system.	X	X	X	X*	X*
<b>2.2.12.1 Fire extinguishing equipment</b>					
Personnel who work in the site or node must have access to hand-held CO <sub>2</sub> extinguishers of at least 6 kg in the building.	X	X	X	X	X
When there are premises or a building for an emergency power generator, this area must be supplied with powder extinguishers.	X	X	X	X	X
<b>2.2.13 Maintenance plan</b>					
Sites and nodes must have a maintenance plan.	X	X	X	X	X
In addition to that specified in the Operational reliability regulations, the maintenance plan must include regular inspection of filters, climate systems, electrical systems, locks and access control systems according to the manufacturer's instructions and, if necessary, clearance of snow, brushwood and grass.	X	X	X	X	X
<b>2.2.14 Other</b>					
There should not be any signs specifying the site's owner etc.	X	X	X	X	X