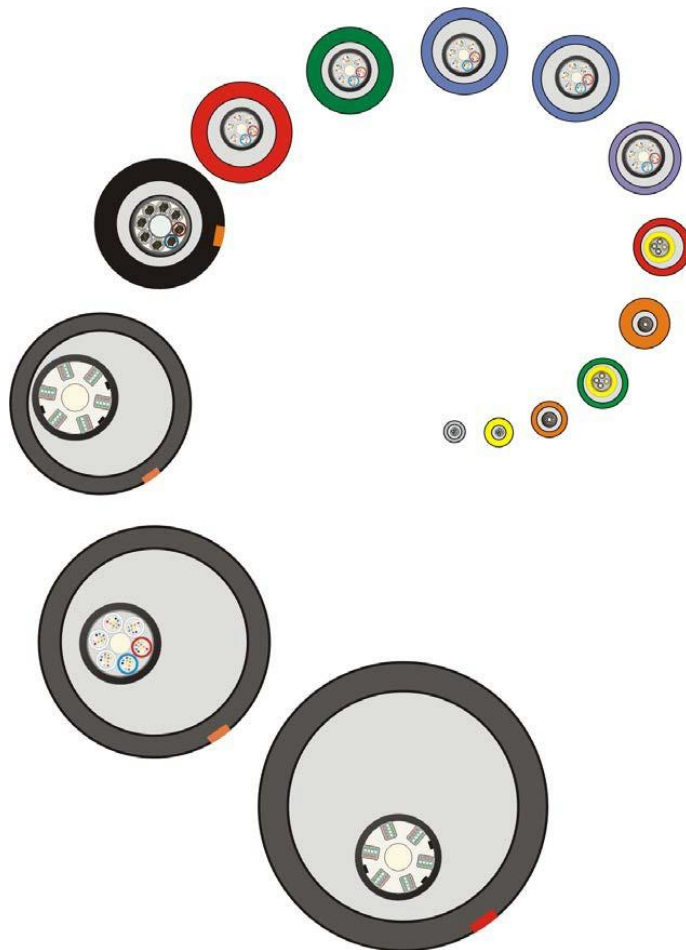




# Instructions for Robust Fiber

## Appendix 2 Robust networks

Ver 1.5





# CONTENTS

|           |  |          |
|-----------|--|----------|
| <b>1.</b> | <b>Introduction</b>  | <b>5</b> |
| <b>2.</b> | <b>Networks</b>  | <b>6</b> |
|           | 2.1 Preparations for routing of ducts and fibre optic cables                 | 6        |
|           | 2.1.1 Plan network structure   | 6        |
|           | 2.1.2 Land investigation   | 6        |
|           | 2.1.3 Permits and land issues  | 7        |
|           | 2.1.4 Cable indication query   | 8        |
|           | 2.1.5 Choice of routing technique  | 8        |
|           | 2.1.6 Self-monitoring  | 8        |
|           | 2.2 Ducting  | 9        |
|           | 2.2.1 Ducts  | 9        |
|           | 2.2.2 Distribution point   | 11       |
|           | 2.2.3 Traceability   | 16       |
|           | 2.3 Routing  | 19       |
|           | 2.3.1 Sealing of ducts   | 19       |
|           | 2.3.2 Underground routing  | 19       |
|           | 2.3.3 Minimum backfil height   | 26       |
|           | 2.3.4 The location of the intake of the duct in a building                   | 29       |
|           | 2.3.6 Routing on poles   | 34       |
|           | 2.3.7 Installation at bridges  | 36       |
|           | 2.3.8 Routing in tunnels and culverts  | 37       |
|           | 2.4 Fibre optic cables   | 38       |
|           | 2.4.1 Fibre optic cables, general  | 38       |
|           | 2.4.2 Fibre optic cables for underground routing                             | 41       |
|           | 2.4.3 Fibre optic cables, cable gutters and cable ladders for indoor routing | 41       |
|           | 2.4.4 Minimum requirements for pole routing                                  | 42       |
|           | 2.4.5 Fibre optic cables for routing in water                                | 42       |
|           | 2.4.6 Fibre optic cables for routing in tunnels and culverts                 | 42       |
|           | 2.5 Cable management   | 43       |
|           | 2.5.1 General requirements   | 43       |
|           | 2.5.3 Routing fibre optic cable indoors                                      | 44       |
|           | 2.5.4 Splicing cables  | 44       |
|           | 2.5.5 Splicing units   | 45       |
|           | 2.5.7 Optical connectors and cleaning  | 48       |
|           | 2.5.8 Termination outdoors   | 50       |
|           | 2.5.9 Termination in house   | 50       |
|           | 2.5.10 Optical radiation   | 51       |
|           | 2.5.11 Delivery measurement of fibre connections                             | 51       |
|           | 2.5.12 Delivery measurement of passive fibre                                 | 52       |
|           | 2.5.13 Delivery measurement of active fibre                                  | 53       |
|           | 2.6 Labelling  | 54       |
|           | 2.6.1 Labelling and designation of ducts                                     | 54       |
|           | 2.6.2 Labelling cables   | 55       |

|       |   |    |
|-------|---|----|
| 2.6.3 | Numbering and labelling of racks and panels | 56 |
| 2.6.4 | Splicing units                              | 56 |
| 2.6.5 | Fibre outlets                               | 56 |
| 2.7   | Safety                                      | 56 |
| 2.7.1 | Locks                                       | 56 |

## 1. INTRODUCTION

The document "*Instructions for Robust Fiber*" comprises one main document and a number of appendices.

This appendix, Robust networks, contains minimum requirements regarding how ducts and fibre optic cables are to be selected, routed, handled, labelled and measured. The appendix also contains recommendations and examples of what it might look like when building a robust fibre installation.

Please note that the network owner may have stricter requirements than those specified in this document.

Minimum requirements within the following areas are defined in the appendix:

- Preparations
- Ducting (ducts, optical fibre chambers and outdoor splice cabinets)
- Position measurement
- Marking
- Sealing of ducts
- Routing ducts in the ground
- Backfill height
- Connection to buildings
- Routing in lakes or watercourses
- Routing on poles
- Installation at bridges
- Routing in tunnels and culverts
- Fibre optic cables
- Cable management
- Splicing
- Splicing units
- Termination
- Delivery measurement of fibres
- Labelling
- Safety

## 2. NETWORKS

### 2.1 Preparations for routing of ducts and fibre optic cables

Prior to commencing the work of routing ducts and fibre optic cables, a number of activities have to be performed.

For further information see Appendix 7 Fiber Construction Projects.

#### 2.1.1 Plan network structure

##### Network structure

Before the work of planning the design of the network, a check must be carried out regarding any need for reinforcement measures for events that may deviate from the normal and that may involve serious disturbances in important societal functions.

Based on the above control, a rough design is carried out that contains the number of possible customers. A proposal is made for a network structure to cover the area, suitable installation technology, shaft lengths and the material in which the shaft takes place.

Based on the network structure in the rough design, a detailed design is made that leads to a choice of size of optical cables and the number of splice units. Then select the type of cabinet or optical fibre chambers. Then, duct pipes must be selected to suit the optical cables selected for the system. It is recommended to plan some overcapacity for both fibre and duct work.

##### Network structure enhanced security

For the completion of facilities with requirements for increased safety, the document Facilities with increased safety and function, Appendix 1, is used. Robust site for essential digital infrastructure and Appendix 2. Passive secure physical connection.

Appendix 1. Robust site for socially important digital infrastructure is an instruction for how the physical protection of sites should be supplemented to be able to withstand serious disruptions. The requirements include requirements for new construction and for rebuilding existing facilities.

Appendix 2. Passive secure physical connection constitutes an instruction with requirements for how the physical protection of electronic communications should be supplemented between sites and between site and user node in order to be able to withstand serious disturbances. The requirements include requirements for new construction and for rebuilding existing facilities.

For the complete versions see: <https://www.ssnf.org/nat-i-varldsklass/robust-digital-infrastruktur/>

**Note.** An existing facility must have undergone a risk and vulnerability analysis (RSA). An existing facility that is being upgraded will undergo a renewed RSA. Threat directories and RSA for Site and Node as well as Robust secure physical connection can be found under:

<https://www.ssnf.org/nat-i-varldsklass/robust-digital-infrastruktur>

#### 2.1.2 Land investigation

A decisive factor in the choice of equipment and routing technique is the implementation of a visual land investigation of the planned cable section.

Before commencing the earthworks, a visual inspection of the work area is therefore conducted. The visual inspection is conducted by appointed representatives of the client and the contractor. Representatives of affected land owners should also be present. The results of the visual inspection are documented in a report, which should be supplemented with pictures of the work area.

Consultation with the Country Administrative Board and/or the local authority regarding culture and the environment is required in certain cases.

This applies in particular in locations where there may be archaeological sites, by watercourses, in the case of unsuitable land, unique vegetation, etc.

### MINIMUM REQUIREMENTS, LAND INVESTIGATION

- Visual inspection prior to implementation must be conducted and reported.
- Necessary contacts in respect of culture and the environment must be made by the network owner.

#### 2.1.3 Permits and land issues

Depending on the cable route, it is necessary to consult with and obtain permits from affected stakeholders, such as landowners and road operators. Land agreements are entered into between the network owner and affected land owners. The network owner is responsible for obtaining land agreements. The network owner may engage another party to carry out this work, e.g., the contractor.

Different stakeholders may administer permits differently. There may be local regulations for the relevant landowner or road operator.

Example list of the requisite permits that may be required in a project.

- General land permit from the local authority regarding the right to have cables in municipal land.
- Land agreements between the network owner and the landowners/plot owners. The agreement shall include the agreed cable position and, where applicable, where the connection of the house will take place. There are different types of land agreements, such as "markupplåtelseavtal, nyttjanderättsavtal, och ledningsrätt".
- Permits/decisions to dig from municipal and/or state road owners, ("Ledningstillstånd" Swedish Transport Administration) /track owners (railway)/ landowners, describing where to place new cables, restoration requirements and the duration of the installation work.
- In some cases, the above point may need to be supplemented with a start-up permit (opening notification) with landowners/road owners e.g. a municipality or a road association/community.
- Cable location from landowner, e.g., local authority, Swedish Transport Administration or road operator. Regulates where the cable may be located.
- Co-location Agreement - Regulates the terms and conditions of co-location.
- TA plan according to the regulations of the road manager. (For the Swedish Transport Administration see Permission for the placement of telecommunication lines).
- Permission from the Swedish Transport Administration regarding the placement of telecommunication lines. The conditions for traffic and protective devices are obtained together with the decision on Permission for the placement of telecommunication lines. For further information, see the Swedish Transport Administration's publication "Ledningsarbete inom det statliga vägområdet".
- Building consents
- Permits from pole route owners.
- Consultation with the Country Administrative Board and/or the local authority regarding culture and the environment (watercourses, archaeological sites, alleys, unsuitable land, unique vegetation, cultural monuments).
- Consultation with the County Administrative Board if, outside areas with a detailed plan, buildings are to be erected, extensions made, other facilities carried out or other such measures are taken that may adversely affect traffic safety within a distance of twelve meters from a road area (Road Act 47§).

**MINIMUM REQUIREMENTS, PERMITS AND AGREEMENTS:**

- Necessary permits must be obtained.
- Land agreements must be drawn up between the network owner and affected landowners/plot owners. The agreement shall include the agreed cable position and, where applicable, where the connection of houses will take place.
- Land agreements between the network owner and the road operator must be drawn up. The agreement shall include the agreed cable position.
- Local regulations must be complied with.
- Cable indication queries are created in Ledningskollen (see Appendix 8 Ledningskollen) and any local procedures.

**2.1.4 Cable indication query**

Before commencing the work of routing ducts and fibre optic cables, a query is created in the national service Ledningskollen (see Appendix 8 Ledningskollen) and in accordance with any other local procedures. Other cable owners in the area can thereby receive information about the planned work.

Cable indication queries from affected cable owners are ordered by the contractor where necessary. This is done to minimise the risk of damaging existing cables.

**2.1.5 Choice of routing technique**

Applicable routing methods are determined based on the results of the land investigation and local regulations. Agreements regarding the selected routing method per section are documented in the minutes of a Construction meeting or equivalent. Information about the relevant routing method and when the method is most suitable can be found in the appendix Routing methods.

**2.1.6 Self-monitoring**

Located channeling is difficult to check why the contractor should carry out self-control.

**MINIMUM REQUIREMENT**

The contractor's quality plan must state how the contractor intends to carry out and document his own control. The inspection shall be carried out and documented per leg. Procedures for photo and self-checks must be checked with the customer before construction starts.



## 2.2 Ducting

Ducting refers to the components that jointly form the transfer route and protection for one or more fibre optic cables. Ducts (standard or microducts) emerge from a node, optical fibre chamber or cabinet and constitute the transfer route to the next node, optical fibre chamber, cabinet or to the end customer.

### 2.2.1 Ducts

Ducts in which fibre optic cables are to be laid can be divided into standard ducts and microducts. They are normally made of high-density polyethylene (HDPE). The inside of the ducts is made from low-friction, anti-static plastic in order to promote the maximum length of cable installation sections.

More robust ducts are also available, and these are used in the ground to surround standard ducts and microducts. Dimensions with an outer diameter ranging from 50 mm up to 160 mm are most common.

When selecting ducts for routing in the ground, consideration is given to the ground conditions where routing is to take place, the method with which the ducts are to be routed and that the ducts are appropriate for the technique that is to be used to install the fibre optic cable.

When selecting duct, it is important to ensure that the supplier has mechanical seals that fit the selected fibre optic cable, see also under Outdoor splice cabinets and sealing of ducts.

Ducts for direct installation in soil shall, as a rule of thumb, have a thickness of at least 1.8 mm. If the ducts are to be used for blowing or flushing in fibre optic cable, it is recommended that:

- The diameter of the fibre optic cable should not exceed 75% of the inner diameter of the ducts when blowing fibre optic cable. Follow the manufacturer's recommendation. The ducts can cope with the air pressure that is required to blow in a micro-cable or fibre optic cable. The air pressure when blowing in fibre optic cable is normally 8–10 bar. The ducts should therefore be specified as able to cope with 50% higher air pressure for a limited period. Prior to blowing, it is therefore necessary to check with the material supplier what is recommended as optical fibre chamber as the maximum air pressure for the relevant duct's dimensions.

### MINIMUM REQUIREMENTS, DUCTS:

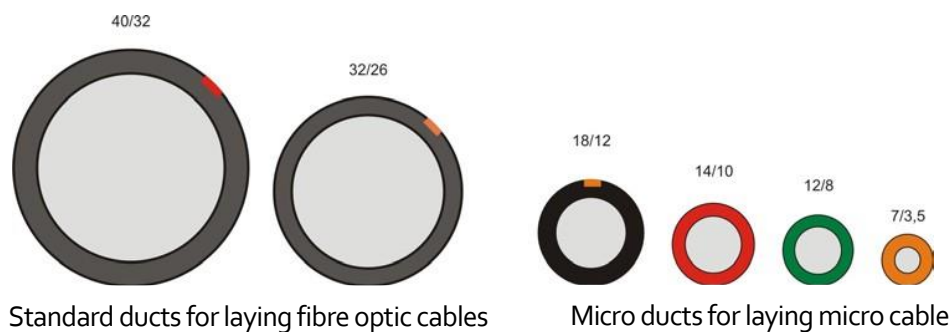
- Underground splice connections must be safeguarded in accordance with the manufacturer's instructions.
- The ducts must be designed for the routing of fibre optic cables and must have low internal friction.
- The type of duct must be selected according to the method being used for routing the ducts. The manufacturer's recommendations must always be followed.
- Annular rigidity and wall thickness must be of the correct dimensions for the conditions the ducts have to handle after routing. The manufacturer's specifications must be followed.
- The material manufacturer must be able to demonstrate that the ducts are ageing-resistant and specified for an anticipated service life of at least 30 years.
- The ducts must not contain environmentally hazardous materials, e.g., lead stabilisers.

- Where there is a risk of attack by pests, ducts with high resistance to attack must be selected. Alternatively, additional protection must be installed outside the existing ducts.
- The storage and handling of ducts must take place in accordance with the manufacturer's specifications in respect of UV light, temperature, environment, routing, winding, etc.
- Ducts must be spliced with a sealed splice connection according to the manufacturer's instructions.
- When jointing duct pipes, these should not have too much temperature difference to the joint to prevent creep.
- When cutting ducts, cut the ducts with tools for cutting ducts. This is to avoid degrees, cuts, etc. which in turn can lead to blow problems.

One problem that can arise is that moisture penetrates into the duct when blowing in (if there is no dehumidification), at splices, at ends or through the plastic material. If the moisture freezes to ice in the duct, the fibre optic cable can be damaged through tensile or crushing damage.

For this reason, the following requirements must also be satisfied:

- In order to minimise the risk of damage, the fibre optic cable must have sufficient strain relief and, with the exception of blown fibres and nanocables, be longitudinally watertight, for example with filler or a swelling material. If the fibre optic cable does not have this, the duct must be fully moisture protected with sealed splices.



*Examples of ducts in various dimensions.*

#### 2.2.1.1 Standard ducts

Standard ducts are intended for routing directly in the ground, water or air.

Ducts designed for routing directly in the ground must have a material thickness that is dimensioned to cope with the pressure from the surrounding soil. This must be specified in the product description from the manufacturer of the standard duct. It is generally the case that, in the event of larger outer diameters, a greater material thickness is required in order to retain annular rigidity.

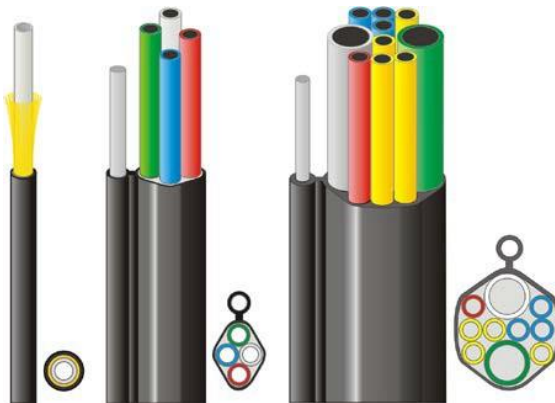
#### MINIMUM REQUIREMENTS

The manufacturer must state in his duct specification that the duct is dimensioned with a thickness of goods to withstand pressure from the surrounding soil.

### 2.2.1.2 Microducts

Microducts are thin-walled ducts (sub-ducts or for indoor use) or thick-walled ducts (for direct routing in the ground, water or air). 16/12, 14/10, 12/10 (no direct routing) and 7/3.5 mm are common. Microducts are used to blow (in certain cases also to pull) micro-cables or blow fibres.

Microducts for above ground installation have in-built strain relief in the form of aramid yarn or fibreglass-reinforced plastic rods. Always use the tensioning and mounting devices recommended by the manufacturer for the microduct being installed.



*Microducts for aerial installation*



*Examples of splicing of microducts*

### 2.2.1.3 Labelling and identification of ducts

Labelling of ducts will aid the identification of ducts in the network. Identification is achieved through e.g., coloured, corrugated or numbered ducts in order that the ducts can be distinguished in the event they are excavated or damaged and, for example, when fibre optic cables being blown in from outdoor splice cabinets.

### 2.2.2 Distribution point

A distribution point is a space, a node, a manhole or a cabinet in which ducts and fibre optic cables start, branch or terminate. Examples include access nodes, cable manholes or outdoor splice cabinets.

The type of distribution point is selected on the basis of the geographic location as well

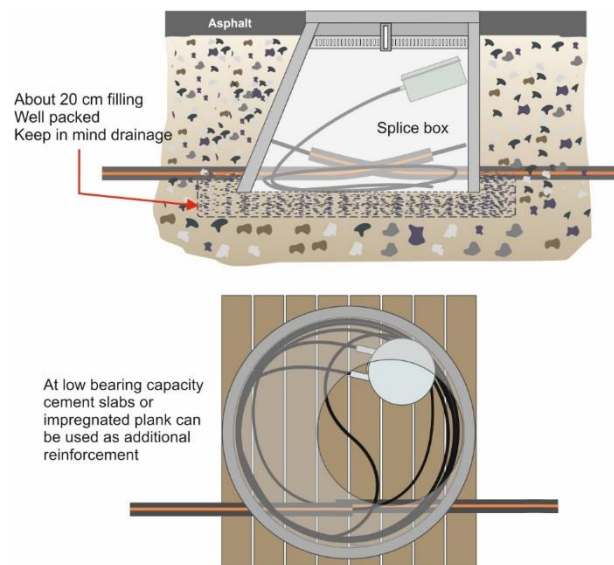
as the number of ducts, fibre optic cables and splicing units that are to be included at the distribution point.

### 2.2.2.1 Optical fibre chambers

An optical fibre chamber is part of the ducting.

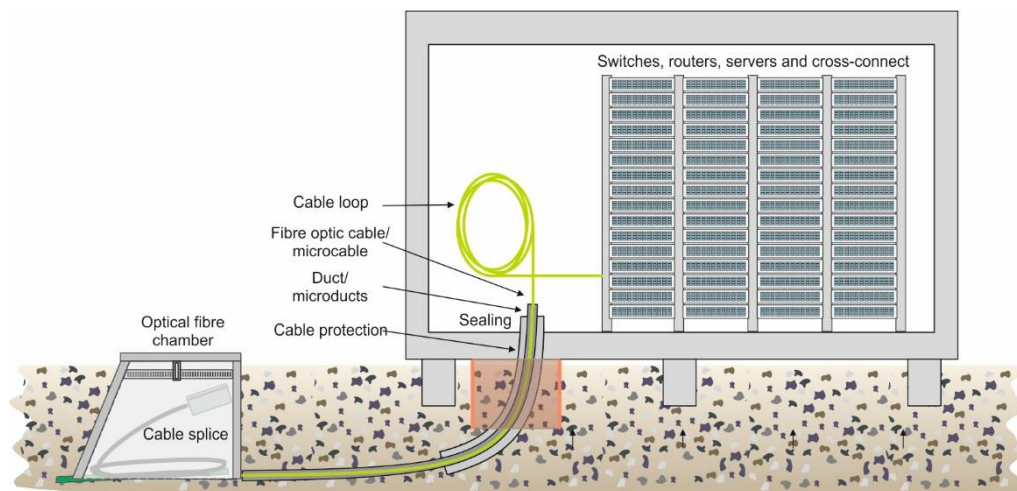
Optical fibre chambers are available in several different versions and are adapted according to where they are to be located and what they are to contain. The optical fibre chamber can be made of concrete, cast iron or plastic. Ideally select an optical fibre chamber body that is sectioned, which provides a flexible solution in terms of depth and the creation of optical fibre chambers for incoming ducts.

Optical fibre chambers are available that are intended for placing in various environments, e.g., hard surfacing (roadway, pavements) or for burying in greenfield sites. The shape of chambers can vary, e.g., round or square.



*Examples of optical fibre chambers*

Intake chambers should be located close to a node. Ducts should be interrupted there to avoid the risk of water penetrating into the node.



*Example of intake fibre chamber*

#### MINIMUM REQUIREMENTS, OPTICAL FIBRE CHAMBERS:

- The optical fibre chamber type must be designed for the environment in which it is located, e.g., roadway, pavement or buried in a greenfield site.
- Particular consideration must be given to strength. The manufacturer's regulations and recommendations must be followed.
- When choosing an optical fibre chamber, consideration must be given to the types of ducts and fibre optic cables that may be installed in the optical fibre chamber, bearing in mind minimum bend radius, type of splicing box as optical fibre chamber as the number of ducts and fibre optic cables.
- Ducts installed in the optical fibre chamber should not be bundled.
- Ducts installed in a optical fibre chamber should be pulled into the center of the optical fibre chamber to minimize the risk of the pipe creeping out. This should be done with consideration that the establishment and usability of fibre will not be impaired.
- Visible optical fibre chambers (not covered) must be locked to prevent unauthorised access.
- The contents of the optical fibre chamber must not be evident from the outside of the chamber.
- Optical fibre chambers should be positioned in such a way as to minimize the risk of water ingress and so that the required drainage can be carried out.
- Optical fibre chambers must be placed in such a way that the risk of damage during ditch cleaning is minimized.
- Optical fibre chambers placement planning should be based on site visits.
- Optical fibre chambers must be placed in agreement with the landowner. Pay special attention to the work environment regarding danger to persons during installation and service.

#### Recommendation

- The contractor's self-inspection should include photo documentation of the optical fibre chambers design and location.
- Placement of optical fibre chambers in trenches should be avoided.
- Placement of optical fibre chambers in trenches should be avoided.

### 2.2.2.2 Outdoor splice cabinet

An outdoor splice cabinet is part of the ducting.

The choice of outdoor splice cabinet is made on the basis of the number of cables and fibres as well as the number of splices that are to be handled. Then select cabinet type and the size of the outdoor splice cabinet. There must be enough space for a loop with a sufficient minimum bend radius as well as for splicing units.



*Example of outdoor splice cabinet with splici*

### MINIMUM REQUIREMENTS, OUTDOOR SPLICE CABINET:

- The cabinet must be of class IP<sub>34</sub> or higher.
- The cabinet be of class IK<sub>10</sub> or equivalent.
- The cabinet must achieve corrosion class C<sub>3</sub> for the specified service life of the ducting.
- Outdoor splice cabinets must be made of corrosion-resistant material or have a corrosion-inhibiting surface treatment.
- Outdoor splice cabinets must be locked mechanically or electromechanically.
- Outdoor splice cabinet must be adapted for simplicity of post-connection.
- Installation work in outdoor splice cabinets must be possible without affecting the function of existing installation.
- Splice unit in outdoor splice cabinets must be installed according to the manufacturer's instructions.
- Design of outdoor splice cabinets placement should be based on site visits.
- Outdoor splice cabinet must be placed in agreement with the landowner. Pay special attention to the work environment regarding danger to persons during installation and service.

Indoor cabinets do not need to be locked if the premises are locked and only authorised parties are granted access.



### 2.2.2.3 Moisture in outdoor splice cabinet

Moisture in outdoor splice cabinets can cause problems in terminations, splicing units, splices and cables. This can lead to operational problems and a reduced service life. Ground moisture is one of the major sources of problems.

For this reason, the following requirements must also be satisfied:

- If a cabinet has been supplied with a ground insulation plate, this must always be installed in accordance with the manufacturer's regulations. All openings between the plate and cabinet, cable and other bushings must be sealed.
- If a cabinet has been supplied without a ground insulation plate, some other ground insulation must be installed, e.g., in the form of Leca granules. For use of lecles, see section 2.3.2.2
- The sealing of ducts in outdoor splice cabinets must be performed above the ground insulation plate or other insulation and must be carried out through mechanical sealing that is appropriate for the ducts in question.
- In the event thick-walled microducts that are bundled through a plastic casing are used, the plastic casing must be cut below the ground insulation plate during installation in an outdoor splice cabinet. This is to prevent water from making its way up into the cabinet, see image below.



*Example of correctly slotted casing*



*Example of correct sealing of duct*

### 2.2.3 Traceability

In order to facilitate the tracing of underground ducts, position measurement must always be conducted. As a complement, a search wire should be installed together with the ducts. Warning mesh, warning net or other clear marking should be placed above the ducts to reduce the risk of damage to the cable infrastructure.

#### 2.2.3.1 Position measurement

Position measurement means that the geographic location of the fibre installation is measured in the form of coordinates that can be displayed on a map.

#### MINIMUM REQUIREMENTS, POSITION MEASUREMENT:

- Measurement of the position of the fibre installation must be carried out using geodetic measurement with a DGPS (differential GPS) measuring instrument or equivalent.
- Measurement must be carried out with accuracy class 2 ( $\leq 0.25$  metres) or even greater precision. For this reason, it may be necessary in certain cases to measure the actual position before the trench is refilled in order to ensure the quality of the measurement.
- The coordinate system that is used must be specified, e.g., WGS 84, RT 90 2.5 gon V, SWEREF 99 TM or SWEREF 99 (local zone).
- When drilling and pressing, the depth must be measured in accordance with Annex 3.
- The fibre installation must be measured, i.e. ducts, all termination points for ducts, cabinets, optical fibre chambers and cable trays, ducts end points as well as cable fixation points.
- The position of the ends of ducts that are left in the ground for future use must be measured.
- For optical fibre chambers, cabinets and cable trays, the mid-point must be measured.
- For ducts, the start and end points, waypoints, all crossings of streets and roads as well as the location of intakes in buildings must be measured.
- Between waypoints, measurements must be performed at intervals of at least every 50 metres within built-up areas and within at least every 100 metres outside of built-up areas.
- Turns/bends/curves must be measured at intervals of 5–10 metres depending on the radius or the distance that is appropriate for the specific point.

#### Recommendation for position measurement:

- For standard ducts, it is recommended that all splices be measured.

#### 2.2.3.2 Marking

Marking refers to the placing of clear marking above the ducts when routing in the ground.

#### MINIMUM REQUIREMENTS, CABLE MARKING IN THE GROUND

- Warning mesh or warning net with green alternatively orange colour should be placed above ducts\* to reduce the risk of damage to the cable infrastructure.
- The warning must be centred, approximately 10 cm above the ducts.
- The warning must be made of a material that is ageing-resistant in the ground, and must have good handling properties, even at low temperatures.
- The colour of the warning must be clear.

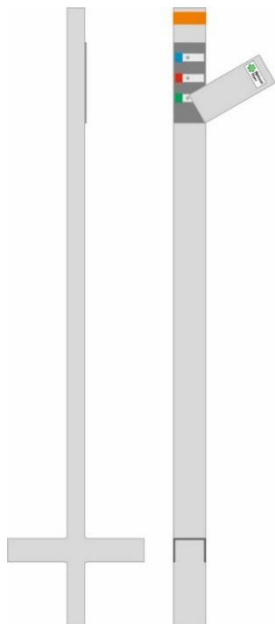
\* Note: Excluded for pressed or controlled drilling when laying ducts under roads, watercourses, etc....



In order to simplify traceability search wire should be used. Alternatively, a separate search wire can be routed above or below the ducts.

#### MINIMUM REQUIREMENTS IF SEARCH WIRE IS USED:

- The search wire must be made of acid-resistant, stainless-steel wire.
- The search wire must be accessible (at screw or similar) in nodes, optical fibre chambers, cabinets or cable fixation points.
- The search wire must be insulated from earth in order not to short-circuit the cable locator's signal.
- Each sub-section with search wire must not exceed 1,000 metres, as cable locators can normally only manage 500–700 metres.
- The search wire's sub-section may not exceed 500 m when crossing electricity lines greater than 130 kV or in the case of extended distances parallel with and closer than 150 m to an electricity line greater than 130 kV.
- The search wire must be spliced in accordance with the supplier's regulations using tools and splicing accessories designated for this purpose.
- When crossing (drilling/pressing) roads where the fibre optic cable is routed in ducts, the search wire must be included in the duct.
- Search wire must generally not be inside a protective duct except in the case of pressing and drilling, when it is placed in the duct.



#### *Cable fixation points for accessing search wire*

##### **Recommendation**

If there is more than one KUP, or several search wires not connected to KUP at the point of spread, marking is recommended with which distance the search wire(s) follow.

Another way of marking buried ducts is to use search balls or search pegs.

These are entirely passive and require no energy, and so they have an extremely long service life. The search field around the ball or peg has a radius of approx. 1.5 m.

This means that it is extremely practical to place search balls in covered optical fibre chambers and at buried duct ends. A special search instrument is used to locate a search ball or search peg. These are available for various purposes and work at various frequencies in order to distinguish different infrastructure.

| <b>Colour</b> | <b>Frequency</b> | <b>Area of application</b>  |
|---------------|------------------|-----------------------------|
| red           | 169.8 kHz        | electricity                 |
| blue          | 145.7 kHz        | water                       |
| green         | 121.6 kHz        | drain                       |
| orange        | 101.4 kHz        | telecommunications          |
| yellow        | 83 kHz           | gas                         |
| black and red | 77 kHz           | cable TV                    |
| lilac         | 66.35 kHz        | often used by private users |



*Examples of search balls and search pegs*

## 2.3 Routing

Ducts and fibre optic cables are normally routed in the ground, although there are several alternatives, see below.

The duct is routed such that the risk of attack by pests is minimised, for example through additional rodent protection and end sealing of ducts.

### 2.3.1 Sealing of ducts

#### MINIMUM REQUIREMENTS FOR SEALING OF DUCTS:

- Ducts must be sealed so that dirt and water cannot penetrate into the ducts. This applies to all end points where new or existing ducts are used.
- The seals must be able to cope with a water column of at least 5 m (0,5 bar).
- The duct ends in any sub-ducts (ducting arranged within an existing duct) must be properly sealed during and after installation.

### 2.3.2 Underground routing

The basic purpose of burying ducts is that the fibre installation is then protected in the safest way. This means that the fibre installation is as robust as possible.

For underground routing, there are a number of methods that are suitable to differing degrees depending on ground conditions, local regulations, etc. More detailed information about methods and when they are appropriate to use can be found in the appendix "Routing methods".

The planned routing method is adapted if necessary to the actual conditions in conjunction with implementation in order e.g., to achieve more efficient routing or meet the requirements regarding backfill height.

It is important to comply with local regulations regarding backfill height, methods, distance to existing ducts, etc.

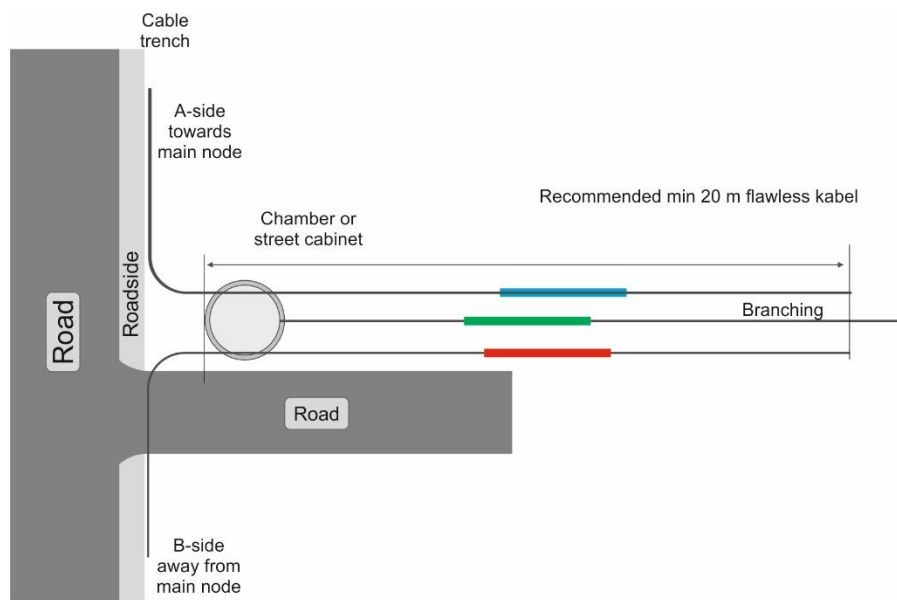
#### MINIMUM REQUIREMENTS FOR UNDERGROUND ROUTING:

- The projected placement method must be adapted to real conditions.
- When routing in the ground, ducts must be laid flat.
- Asphalt must not be laid on top of optical fibre chambers.
- In snowy areas or in the case of dense vegetation, outdoor splice cabinets must be supplied with a marker rod to avoid collision damage and to make the cabinets easier to find.
- Outdoor splice cabinets must be labelled in accordance with the client's instructions.
- Labelling must take place in such a way that the contents are not disclosed.
- Ducts may not be spliced in curves or bends.
- Avoid placing optical fibre chambers in dips due to the risk of water penetration.
- When pressing through a railway bank, the Swedish Transport Administration's instructions must be followed.
- Before excavation in farmland a reconciliation with the landowner regarding existing drainage must be carried out
- When laying in farmland that is used with machines that risk getting close to the depth at which the canalisation is to be laid, it is recommended that a deeper laying is considered

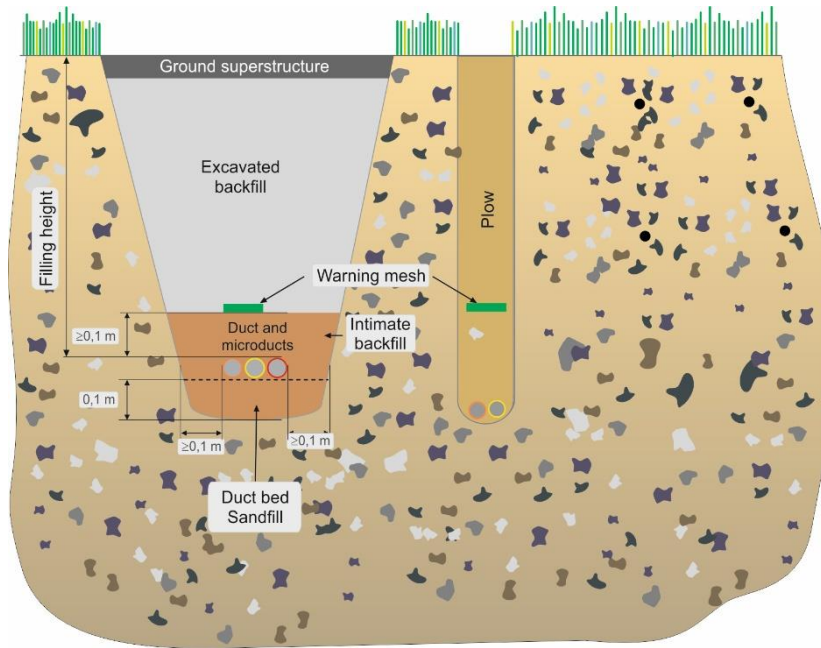
- Any excavated drainage pipes must be photo-documented before and after repair and notified to the landowner during post-inspection.
- When laying in the vicinity of free-hanging power lines and when crossing another line owner's infrastructure, check the line owner's requirements for minimum distances.

**Recommendations for underground routing:**

- Placing optical fibre chambers in roadways, bus stops or car parks should be avoided as far as possible, as special requirements apply regarding strength and permits are required from road operators. Such locations are also unsuitable from a maintenance or a working environment perspective.
- Locating outdoor splice cabinets by road intersections, by snow deposits and in positions where visibility is obscured for road users and residents should be avoided. Consideration must also be given to the work environment of those who will be working at the cabinet. Position the cabinet in a well protected location in order to minimise the risk of e.g., damage, collision damage or injuries caused by snow and brushwood clearance vehicles.
- The duct must be routed at such an incline that water cannot accumulate in the duct.
- Avoid routing ducts over tree root systems. There is a considerable risk of damage if the tree falls over.
- To avoid mistakes when splicing in optical fibre chambers and ground cabinets and to help with troubleshooting, cable from the A-side to the splice unit should be marked with blue tape, cable from the splice unit to the B-side should be marked with red tape and cable from the branch should be marked with green tape.



*Examples of marking cables in optical fibre chambers and cabinets*



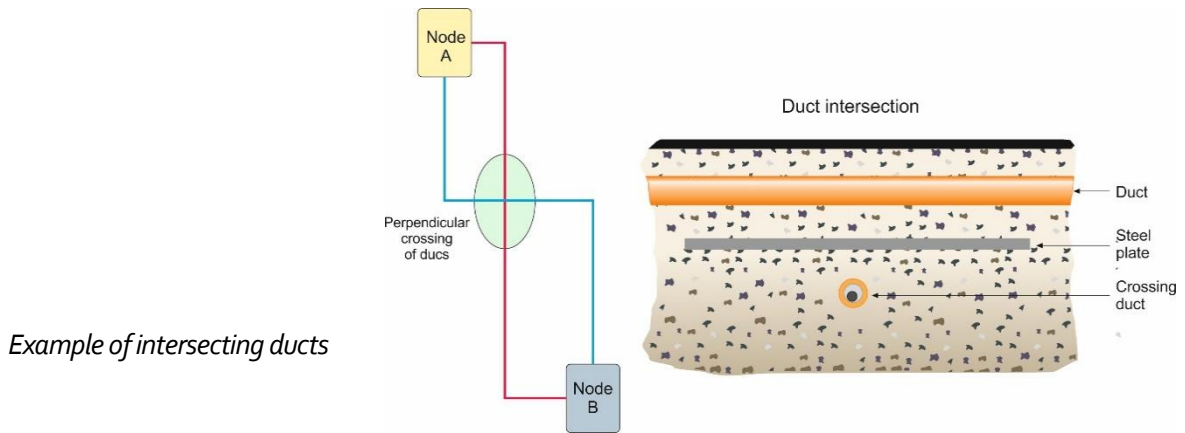
### *Examples of excavations*

During underground routing, it is important to bear in mind that ducts are affected by changes in temperature. This is particularly important when routing over extended distances in warm weather and direct sunlight. Warm ducts can contract when they are placed in cooler ground and covered. You are recommended to leave splices and ends uncovered until the ducts have been adapted to the ambient temperature. Always comply with the manufacturer's recommendations regarding the handling of ducts.

Redundancy is used to minimise the risk of interruptions if a transfer route is damaged. Connections that are supplied with redundancy have two or more transfer routes. Particular requirements then apply in order to keep the various transfer routes separate from each other within the fibre installation.

### **MINIMUM REQUIREMENTS AT DUCTING INTERSECTIONS IN ORDER TO SATISFY THE DEMANDS FOR REDUNDANCY:**

- Ducting intersections must be arranged at a 90° angle.
- One metre before and after the intersection, special mechanical protection must be arranged if the distance between the ducts is less than 2 metres (e.g., vertically). Special mechanical protection means some form of excavation-safe protection, e.g., a 10 mm thick steel plate or equivalent.

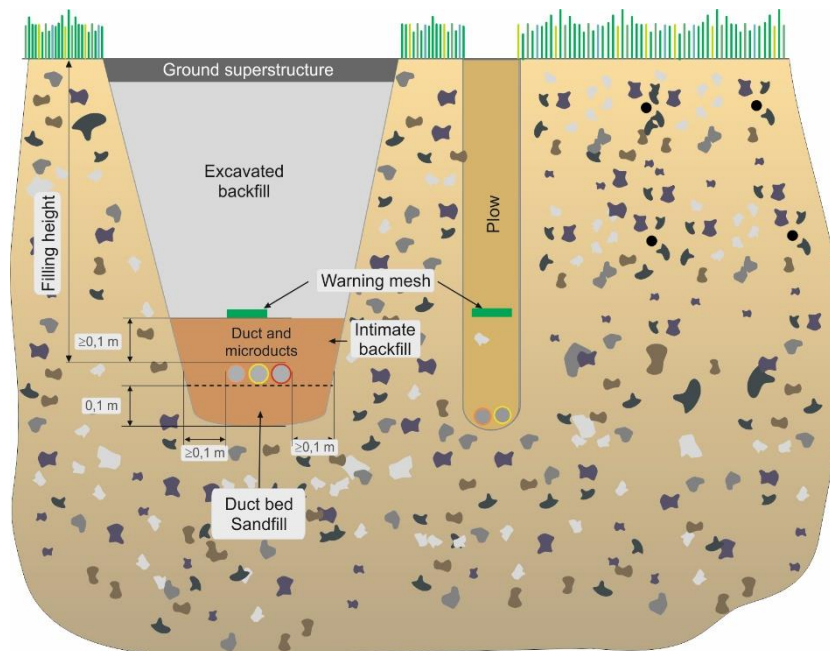


### 2.3.2.1 Bed in ducts

Depending on the routing method, there is a requirement for backfilling and duct bedding.

#### MINIMUM REQUIREMENTS FOR SELECTED SANDFILL AND DUCT BEDDING:

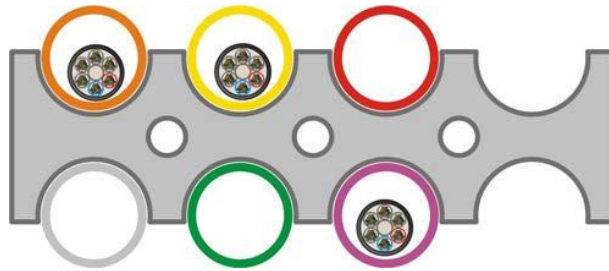
- Duct bedding and Selected Sandfill must comprise filler material in accordance with section 2.3.2.6.
- Measures must be taken so that backfill and duct bedding remain intact.
- When routing several ducts at the same time, there must be backfill around the entire ducts, such that there are no air pockets between them.



*Examples of duct bedding and backfill*

Incorrectly conducted backfilling entails a risk of the ducts being pressed together when the refill material is compressed.

In order to maintain the distance between the ducts during compression, spacers are also recommended for the ducts.



*Example of spacers for ducts*

### 2.3.2.2 Positioning of optical fibre chambers and cabinets

The following applies when positioning optical fibre chambers and outdoor splice cabinets.

#### **MINIMUM REQUIREMENTS WHEN POSITIONING OPTICAL FIBRE CHAMBERS:**

- The bottom section must be positioned on a bed with well-functioning drainage capacity. The grain size of the material must be adapted to the current soil condition. The bed must be well compacted and levelled off and must be at least 200 mm thick. Consideration must be given to any differences in level at the surface when creating the bed. Any need for a ground cloth should be considered.
- Instructions from the supplier must be complied with when positioning optical fibre chamber.

#### **Recommendations when positioning optical fibre chambers:**

- If the ground/surface has a low bearing capacity, impregnated planks or cement slabs should be placed below the chamber body in order to reduce ground pressure.
- In order to keep the inside of the chamber cleaner and to increase the bearing capacity, non-woven fabric can also be placed beneath the bed.

#### **MINIMUM REQUIREMENTS WHEN POSITIONING OUTDOOR GROUND CABINETS:**

- Outdoor ground cabinets must be positioned on a bed similar to that used for optical fibre chambers.
- Instructions from the supplier must be followed when installing ground cabinets.
- Outdoor ground cabinets should be positioned so that the marking on the outside of the cabinet is at ground level.
- Cabinets must be ground-sealed with ground insulation board and approved sealant or alternatively leca balls.
- If the outdoor ground cabinet is to have ground insulation board, you must fill up with lots up to ground level marking on the inside.
- Outdoor ground cabinets must, considering any risk of danger to persons during installation and servicing, be installed with the cabinet opening facing the street/road.
- The top layer of the ground around the cabinet must be the same as the existing ground surface so that it blends into the environment.
- Backfilling must be performed using "Selected Sandfill", medium gravel.
- Backfilling around the cable cabinet must not contain sharp stones or stones larger than 50mm.

- If the ground conditions are such that there is a risk of the foundations/cabinet becoming unstable, the installation must be reinforced with concrete slabs or impregnated planks.

### Recommendation

If the cabinet is to be filled with leca balls, it should, if possible, be at least 35 cm leca balls and the filling should be finished above ground level.

#### 2.3.2.3 Gauging

One way of checking that the ducts has not been damaged in conjunction with routing is to conduct gauging. An item (a gauge) with a diameter that is slightly smaller than the inner diameter of the duct is pulled or blown through. Gauging should be performed using a gauge of a certain length, not with a gauge in the form of a ball. A ball can easily pass through sections in the ducts that are subsequently impossible for a cable to get through.

#### Recommendations when performing gauging:

- The diameter of the gauge should be approx. 20% less than the inner diameter of the duct.
- The gauge should be in the shape of a duct with cones at either end. Each end should comprise an eyelet for attaching a line.



*Example of gauge*

#### 2.3.2.4 Frost thawing

Before conducting frost thawing, it is important to check what local regulations exist regarding methods for thawing frost.

Ducts and fibre optic cables are sensitive to high heat. It is therefore necessary to always check with the relevant manufacturer before performing frost thawing.

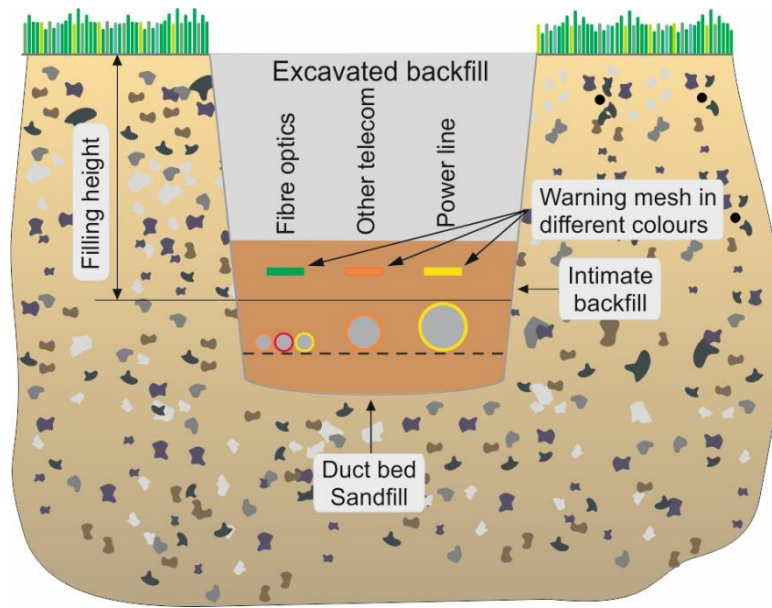
If another cable owner is to perform frost thawing for a cable located deeper than the fibre installation, it is important to point out that ducts and fibre optic cables are sensitive to high temperatures. This is particularly important where the fibre optic cable is routed with little backfill height, e.g., in the case of microtrenching.

#### 2.3.2.5 Collocation

Collocation means that ducts and cables that are owned by several network owners are routed in the same trench. Agreement regarding terms and conditions for collocation is reached between the parties on a case-by-case basis.

The requirements regarding collocation must be at least in accordance with “*Instructions for Robust Fiber*”. It is important to consider different colour marking in the event of collocation.

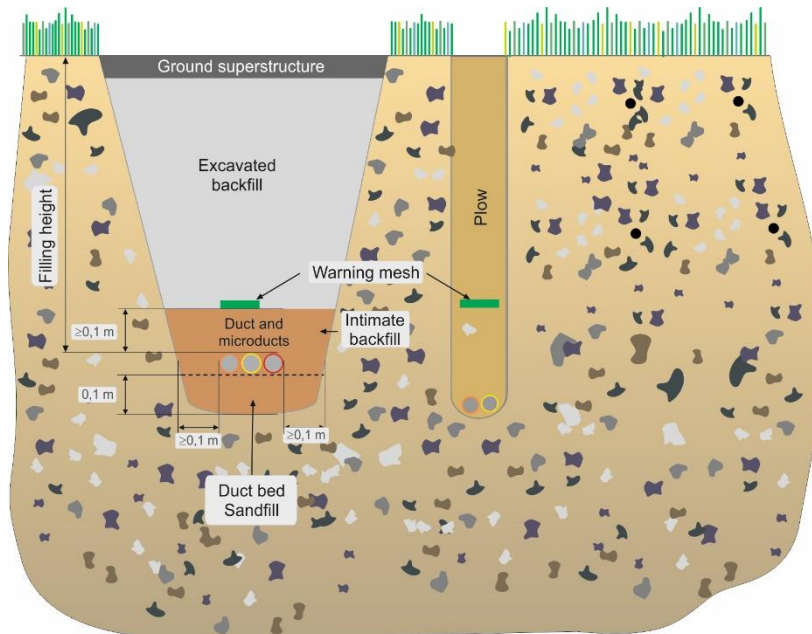




*Image of Collocation*

2.3.2.6 Backfill masses

Backfill masses for shafts when laying ducts include backfill masses for pipe beds, backfill, remaining backfill and ground superstructure as shown below.



*Sandfill*

## MINIMUM REQUIREMENTS FOR FILLING MASSES

- **Backfill surrounding**  
Backfill surrounding shall be at least 0.1 m thick at the side, and over ducts calculated from the top edge of the coarsest pipe.  
Backfill surrounding shall consist of unbroken or crushed material with 0–8 mm grain size.
  - **Existing masses at the bottom of the shaft**  
Existing masses in the trench bottom must correspond to the requirement for backfill surrounding.
  - **Backfilling when existing masses at the bottom of the shaft do not meet the requirement for backfilling.**  
A duct bed with backfilling material, and with a thickness of 0.1 m, calculated from the base of the shaft to the bottom of the lowest ducting pipe, shall be laid under the ducting pipe.
  - **Ground superstructure**  
A fill 0.15–0.2 m is laid at the top of the shaft (0.15–0.2 m) to correspond to existing masses in the rest of the ground.
  - **Remaining filling**  
For the remaining filling of the shaft, filling mass is used which closest to the duct / cable protection does not contain stones with sharp edges and where a maximum of 10 % consists of the grain size of 100–150 mm.
  - **When normal filling height cannot be achieved due to obstacles, such as rock, stone or the like, the following measures must be taken.**
    - Filling material closest to the protective duct may have a maximum grain size of 20 mm.
    - Type, lowest class SRS \* if the filling height > 0.25 m.
    - Type, minimum class SRE \* if the filling height < 0.25 m. In the case of open installation, the manufacturer's instructions must be followed.
- \* Duct / pipe class EBR: SRS / Protection / Pipes / Difficult conditions)  
\* Duct / pipe class EBR: SRE (Protection / Pipe / Extra strong)

**Note.** For in-depth information on fillers, see AMA facility.

### 2.3.3 Minimum backfill height

Backfill height is the distance between the upper edge of the buried duct and the finished ground level. General requirements regarding minimum backfill height can be seen from the table below.

Other requirements and regulations may be determined by road operators and landowners regarding routing and the placement of cables in e.g., urban areas, by major roads and in farmland.

Local rules and regulations must always be followed.

2.3.3.1 General requirements regarding minimum backfill height:

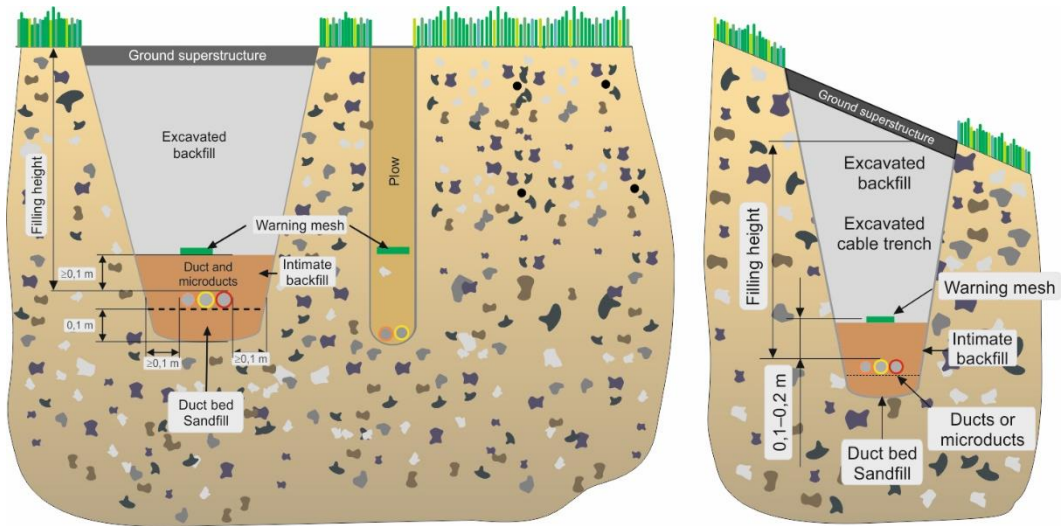
**Minimums backfill height requirements**

- When pressing through a road or railway embankment, the road operator’s and the Swedish Transport Administration’s regulations must be followed.
- For minimum backfill height requirements, see Table Backfill Height below.

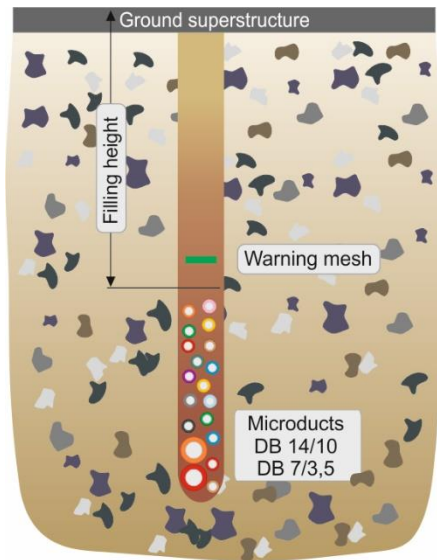
At intersections with other lines, fibre optic cables are normally routed above power cables, water and sewage ducts as well as district heating. Additional protection around the ducts may be required. A risk analysis is recommended to ensure that the correct measures are implemented.

| Surface   | Backfill height | Method                        | Information   |
|---|-----------------|-------------------------------|---|
| Building land adjacent to residential buildings | 30 cm           | All                           |   |
| Roadway and pedestrian/cycle path               | 25 cm           | Microtrenching<br>End milling | An additional 10 cm in the case of non-paved surface (gravel road). |
| Pedestrian/cycle path                           | 30 cm           | All                           |   |
| Crossing of minor road                          | 70 cm           | All                           | Smaller roads such as farm, field or forest road.                   |
| Roadway   | 45 cm           | All                           |   |
| Crossing of ditch                               | 55 cm           | All                           | Calculated from a properly cleared ditch bottom.                    |
| Greenfield sites (not farmland)                 | 45 cm           | All                           |   |
| Green spaces outside of building land           | 45 cm           | All                           |   |
| Farmland  | 75 cm           | All                           | Consideration must be given to any drainage                         |

Table, Backfill height



Examples of backfill heights



Shows backfill height during microtrenching

### 2.3.4 The location of the intake of the duct in a building

A house refers to a villa or terraced house as an individual dwelling. For the connection of apartment buildings, residential, commercial premises, office premises see recommendation "Robusta fastighetsnät".

The position of the intake of the duct in a house is determined by the network owner in consultation with the house owner.

The minimum requirements for connecting a house are presented in the following points.

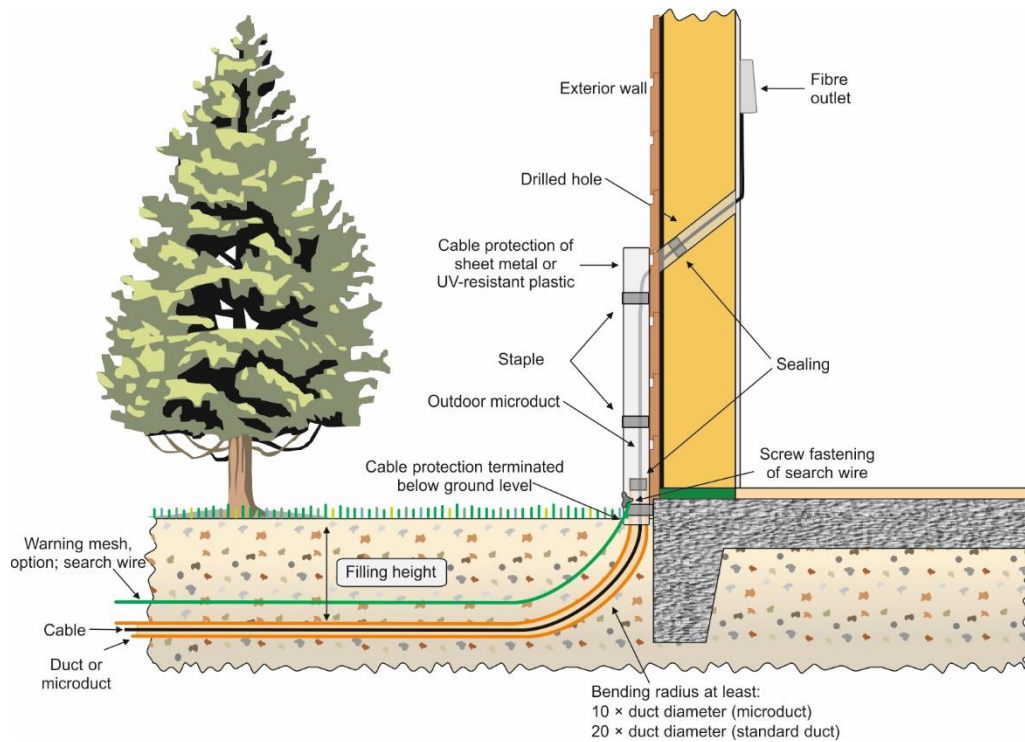
#### 2.3.4.1 Intake of duct above ground level in property

Intake of ducts above ground level shall be determined by the network owner in consultation with the house owner.

The basis for decisions is the network owners risk assessment and local regulations.

### MINIMUM REQUIREMENTS REGARDING INTAKE OF DUCTS ABOVE GROUND LEVEL:

- The bend radius of standard ducts must be at least 20 times the duct's outer diameter, while the bend radius of microducts must be at least 10 times the duct's outer diameter. If not, drawing the fibre optic cable through the duct is rendered more difficult or, in the worst-case scenario, impossible.
- At building foundations, the duct must terminate at least 10 cm above ground level.
- For the cable insertion into the house, a hole must be drilled at an incline of at least 30°, with the highest point inside the house.
- Ducts must be sealed against the hole through the housewall. The space around the duct must therefore be sufficiently large to provide space for a sufficient amount of sealing compound or a mechanical seal.
- Sealing must be performed as close to the inner wall and outer wall as possible.
- The ends of ducts must be sealed until the fibre optic cable is routed to prevent dirt or similar penetrating. Ducts must also be sealed after fibre installation.
- Ducts must be sealed against the fibre optic cable in the fibre outlet to prevent water leaking in from the duct.
- Cable protection that can cope with an outdoor environment must be used to cover visible duct on house walls.
- Marking tapes should be put forward to house life.
- If search wire is used, it must be professionally attached and accessible according to the requirements of the network owner with maintaining insulation.
- Any search wire must be terminated at a screw or cable protection at the house shell.
- UV-sensitiv duct pipes must have mechanical protection (e.g., sheet metal chute) that cover the duct pipe so that the pipe is protected against both mechanical damage and UV light along its entire length.
- In the case of overhead cables, connections must be made in accordance with the manufacturer's instructions.



*Example of intake into building*

#### 2.3.4.2 Intake of duct below ground level

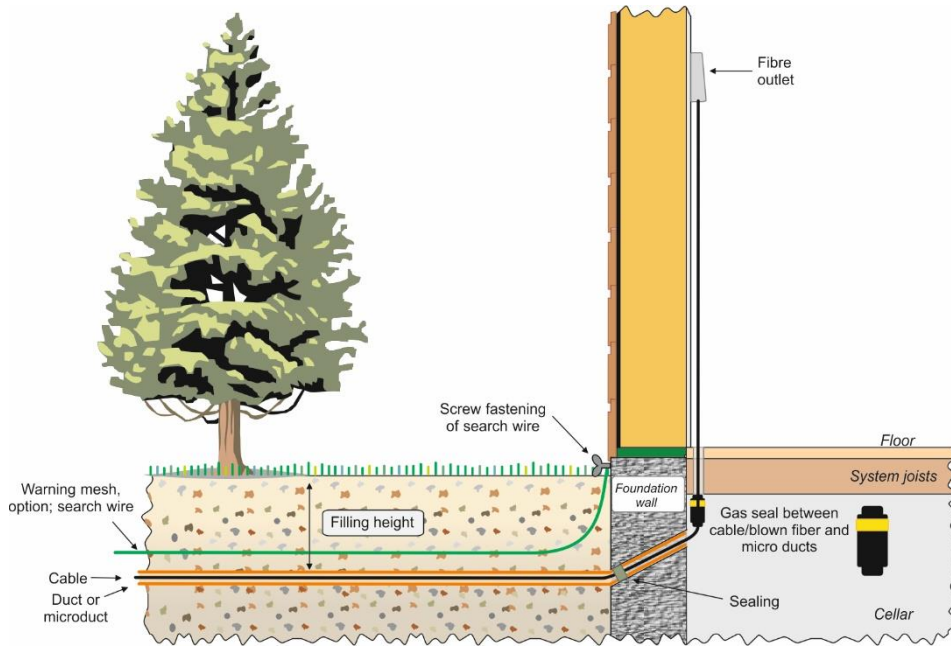
Intake of ducts below ground level shall be determined by the network owner in consultation with the house owner.

The basis for decisions is the network owners risk assessment and local regulations.

#### MINIMUM REQUIREMENTS REGARDING INTAKE OF DUCT BELOW GROUND LEVEL:

- The cable trench must be dug up to the building shell with a backfill height of at least 30 cm above the duct.
- A hole must be drilled into the house at an incline of at least 30°, with the highest point inside the property. If the hole is drilled through the foundation's existing drainage protection, the protection must not be impaired, rather it must be reinstated.
- The duct must be sealed against the hole through the building foundations. The space around the duct must therefore be sufficiently large to provide space for a sufficient amount of sealing compound or a mechanical seal.
- The ends of ducts must be sealed until the fibre optic cable is routed to prevent dirt or similar penetrating. Ducts must also be sealed after fibre installation.
- If search wire is used, it must be professionally attached and accessible according to the requirements of the network owner with maintaining insulation.
- Warning mesh must be placed up to the building shell.
- Any search wire must be terminated at a screw at the building shell.
- If the property has ground cover such as Isodrän or Platon membrane, the manufacturer's recommendations regarding sealing must be followed.





*Example of intake into building*

### 2.3.5 Routing in lakes and watercourses

Before starting routing in lakes or watercourses, it is important to conduct a thorough check of the section in question in order to ensure that the section is suitable with regard to bottom conditions, maritime traffic, etc. It is also common to employ pressing or directional drilling when routing below watercourses. Below is a description of minimum requirements when routing along the bottom.

#### MINIMUM REQUIREMENTS WHEN ROUTING IN LAKES AND WATERCOURSES:

- When routing fibre optic cable in lakes or large watercourses, it is necessary to obtain the consent of the County Administrative Board. In certain cases, an environmental impact plan must also be drawn up.
- Contact must be made with the responsible authorities for the pilotage traffic area to discuss the need for cable marking and signs. The network owner is the sign manager and is responsible for erecting and maintaining the signs.
- Contact must also be made with the responsible authorities for the maritime traffic area in order to discuss the need for landmarking and information for the updating of nautical charts, both after laying and after removal/decommissioning. Requirements for position indication and delivery of digital data must also be established.
- When routing fibre optic cable (underwater cable) or ducts in water, it is necessary to use a design approved for the purpose for placing in water in respect of water depth, the nature of the bottom, future dredging, etc. You must therefore always consult with the cable manufacturer.
- If ducts are intended for water in watercourses, fibre optic cables need not be adapted to water more than the requirements for long-waterproof optocables for ground.
- On lake bottoms where there may be wrecks, rocks or similar, a bottom survey must be conducted to ensure that the cable/duct is routed outside of the risk area.
- When routing underwater cables, the cable must be secured from any tensile forces e.g. by making several turns/loops around a concrete filled drum/ring or similar at both landing points
- When routing underwater cables, a loop must be located at both land attachments, ideally around the outside of a cement ring or equivalent, which then also has an anchoring function.
- After routing, the duct/underwater cable must follow the bottom contours and be securely anchored.
- Duct/underwater cables must be routed at the authorised distance from all types of buoys and beacons.
- When crossing other ducts, such as water and sewage ducts, the duct/underwater cable must be routed under these.  
If this is too difficult to implement, an alternative solution crossing agreement shall be drawn up with the relevant cable owner(s).

#### Recommendations when routing in lakes and watercourses:

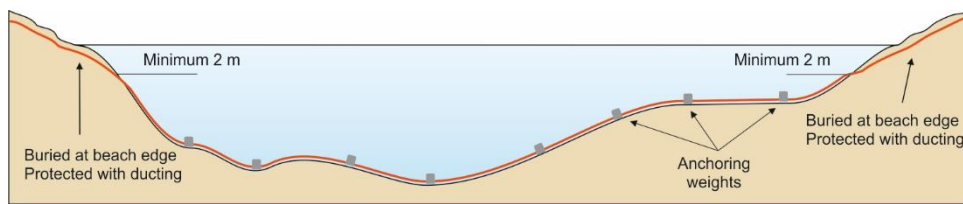
- If there is an obvious risk of damage to cables (e.g., harbour entrances, harbour basins, etc.), an application for an anchoring ban may be considered.
- In navigable channels and in the event of rocky bottom conditions, divers should be used in conjunction with routing to lay the cable properly and, if possible, to secure it.
- When routing cables in lakes, additional duct is not normally required when using an underwater cable. Under certain circumstances, ducts may also be a suitable alternative when routing in a lake. The duct is anchored to the bottom or routed in the lake bed. The duct is normally anchored with weights where there is a risk of it floating up to the surface. The cable can then be flushed into the duct.



- When routing lightly armoured underwater cable, the cable should be anchored to the bottom bearing in mind the cable’s low specific weight.
- In order to facilitate marking out, the duct should be routed in a straight line between the duct’s land attachments.
- When crossing a specifically marked navigable channel or in heavily trafficked channels, crossing should take place at right angles to the channel’s or the maritime traffic’s main direction.
- When crossing smaller watercourses, such as large ditches or streams, re-splicing to maritime cable is not normally required if the cable is routed in a duct intended for underwater routing.
- When crossing larger watercourses, such as rivers or canals where the water is often so deep that normal excavation cannot be performed, the cable is routed in the same way as when routing in lakes.

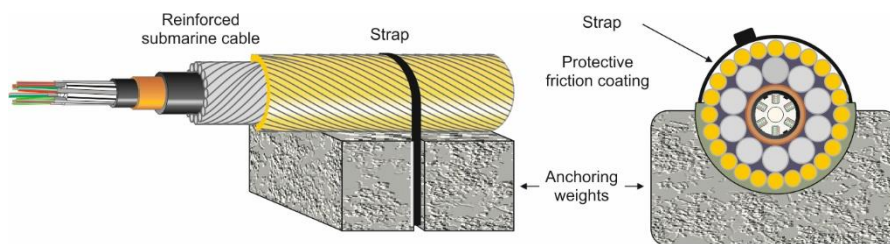
Example of routing with duct in water:

Ducts are routed on the bottom by anchoring them with weights. The weight of the weights is dimensioned according to the diameter of the ducts and with regard to the prevailing water conditions. The weight of the weights and the interval between them must be set out in the planning documentation. Ducts may need to be protected against external effects from e.g., bottom conditions by means of suitable Selected Sandfill, which must be set out in the planning documentation.



*Example showing how a duct is routed on the bottom with the aid of weights*

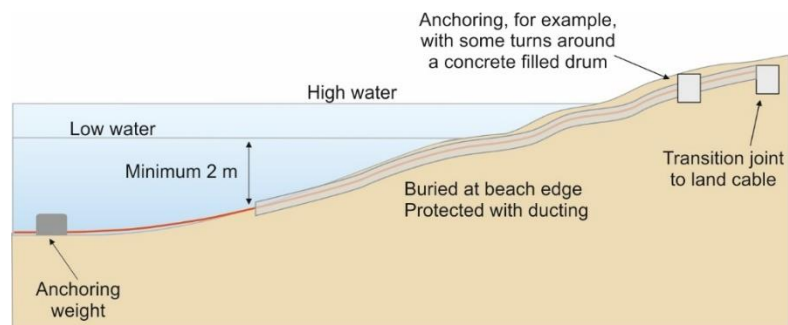
The duct is placed on a weight with a protective friction lining, and then secured with cable ties.



*Example showing how a cable can be secured to a weight. The same principle applies to ducts.*

From the land, the duct must be pressed or drilled out into the lake or excavated down where this is possible. The duct is routed at a recommended depth of approx. 2 metres below the low water level. This is to ensure that the duct is not affected by ice formation.

*Example showing the routing of a duct 2 m below low water level*



#### 2.3.5.1 Extremely fast-flowing water

In extremely fast-flowing water, it is particularly important to select the correct weights to secure the duct to the bottom.

#### 2.3.5.2 Checking routing in lakes or watercourses with regulated maritime traffic in accordance with the regulations of the Maritime Administration.

During or after routing, the duct must be checked by divers. During checking, particular attention must be paid to how the duct is anchored, sufficient routing at the banks, protection and sufficient space between weights. A report of the inspection must be prepared and documented.

### MINIMUM REQUIREMENTS WHEN CHECKING ROUTING IN LAKES AND WATERCOURSES WITH REGULATED MARITIME TRANSPORT:

- Ducts or cables must be inspected by divers.
- A report of the inspection must be prepared.

#### 2.3.6 Routing on poles

From a robustness perspective, routing on poles should be avoided.

When using a pole route, it is necessary to ensure that the pole route's cable corridor is cleared of trees and branches to minimise the risk of damage to the fibre optic cable.

If a pole route is being used for ducts, routing can take place in several different ways.

- Installation on separate poles (separate pole route).
- Joint construction with an electricity grid owner's pole routes for low and medium voltage.
- Utilise phase or earth wire in power line poles through joint construction with an electricity grid owner.
- Joint construction with a telecommunications operator's poles.
- Joint construction with the Swedish Transport Administration or other railway companies' poles.

### MINIMUM REQUIREMENTS FOR ROUTING ON POLES:

- Ensure that the owner of the pole route has procedures for clearing the cable corridor to prevent damage from trees and branches.
- Guys must be present to counteract lateral forces in the event of branching or bends.

#### 2.3.6.1 Joint construction

In the event of joint construction with another owner of poles, it is necessary for responsibility issues, demarcations and maintenance measures to be clarified and documented in an agreement between the owners.

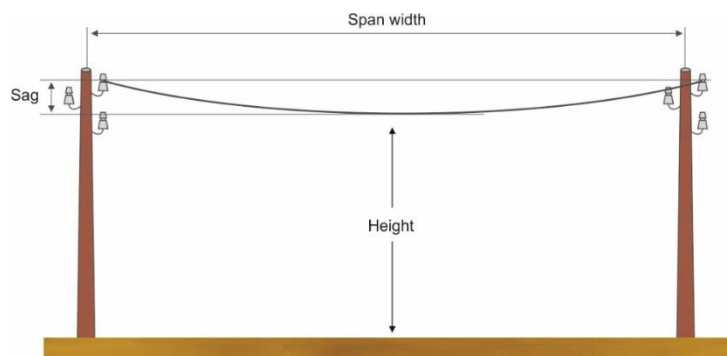
Consult with the relevant party in the event of joint construction to obtain information about which rules and regulations apply. It must be clear from the agreement who owns, maintains and is responsible for inspection, as well as the terms and conditions in the event of any transfer. There must also be a reference to the applicable safety requirements. Particular attention must be paid to authorisation for service and maintenance personnel.

### MINIMUM REQUIREMENTS IN THE EVENT OF JOINT CONSTRUCTION:

- Agreements with the pole owner must be established.
- The pole owner's recommendation for Co-building / Co-location must be used.

#### 2.3.6.2 Height above ground of overhead cables

The distance between cable and ground applies at maximum load and must be calculated from the surface of any snow cover.



Example of overhead cable

### Requirements regarding height above ground of overhead cables:

- The minimum height above ground or water of overhead cables must not be less than 3.5 metres. From the final pole to the building, however, the height may be less.
- In the case of land where vehicles may pass, such as arable land, agricultural land or park environment, the minimum height above ground must be 5 m. Consultation must be held with landowners before installation is carried out.
- The minimum height of the overhead cables over a public road or other area with passing traffic, the installation must be carried out in accordance with the Swedish Transport

Administration's instructions for management work within the road area or other road maintenance instructions. Responsible road maintenance requirements always apply before Robust fiber's instructions if the requirement is higher.

- When suspending an optical cable, EBR K30: 04 regarding co-assembly of optical fibre cable must be followed.
- An overhead line over an area with maritime traffic must be installed at a minimum height above normal high-water surface that the Swedish Maritime Administration or another authority prescribes as a sail-free height.
- When an overhead line crosses an electrified railway, it must be located at the height and in accordance with the instructions determined by the Swedish Electrical Safety Agency after consultation with the railway owner.
- When overhead line installation, the cable manufacturer's instructions on mounting accessories and installation methods must be followed.

### MINIMUM REQUIREMENTS REGARDING INSPECTION OF OVERHEAD CABLE

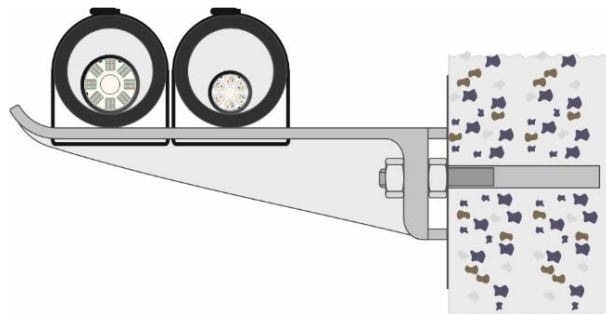
- Inspections are performed in accordance with the pole owner's and the supplier's instructions.

#### 2.3.7 Installation at bridges

The location of ducts on bridges is determined by the road operator/bridge owner in consultation with the contractor.

### MINIMUM REQUIREMENTS REGARDING FOR BRIDGE LAYING:

- The ducts must be securely attached and well protected.
- There must be a cable loop on at least one side of the bridge. Singel customer cables usually do not need to be looped.



*Example of anchoring on a bridge*

### 2.3.8 Routing in tunnels and culverts

When routing in a tunnel, ducting in the form of ducts is not needed.

#### MINIMUM REQUIREMENTS FOR ROUTING IN A TUNNEL:

- Material that is used must be classified for indoor use.
- Fibre optic cables or ducts must be placed on a cable ladder or clamped to the tunnel wall alternative, fibre optic cables and ducts can be installed with a catenary or wire span.
- . Fibre optic cables or ducts must be secured with e.g., cable ties, in which case at least every third cable tie must be made of metal to prevent the cable falling down in the event of a fire.
- If there is a risk of unauthorised entry, vandalism or pests, armoured fibre optic cables or ducts must be used.



*Routing in tunnel*

## 2.4 Fibre optic cables

### 2.4.1 Fibre optic cables, general

For cable designs and the choice of cable, you should generally refer to material suppliers. There are a few different fibre optic cable designs:

- Ribbon cable – the fibres are joined together in ribbon structures (4 or 8 fibres), making it possible to splice (weld) all the fibres at the same time. The ribbon is then placed in a plastic groove profile.
- Cables built up with tubes, where the fibres are protected in filled tubes located around a strain relief device.
- Cables with a central filled tube with fibres with or without external strain relief.
- Micro-cables are built up in a similar way to fibre optic cables, but with a more slender structure.
- Blow fibres are 1–12 fibres bundled with minimal external protection in the form of a sheath. If blow fibres are routed outdoors, only ducts intended for blow fibres may be used.

There are several standards for the colour coding of fibres in fibre optic cable. It is important to decide on a colour code and to use the same colour code throughout the fibre installation.

Colour code S12 is recommended for all fibre optic cables.

### MINIMUM REQUIREMENTS REGARDING FIBRE OPTIC CABLES:

- Fibre optic cables must have single-mode fibres and must conform to the standard according to ITU-T G.652 or G.657.
- The fibre optic cable's strain relief must be adapted to the installation methods and the splicing units that are used in the fibre installation.

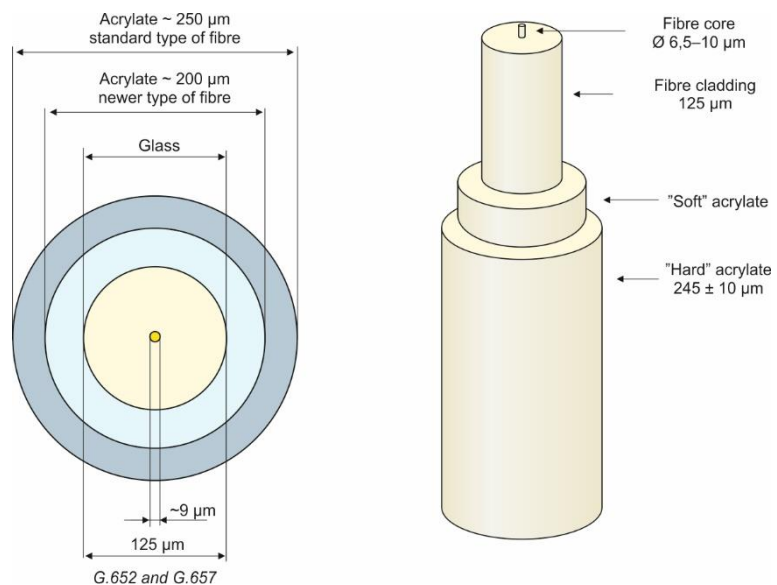
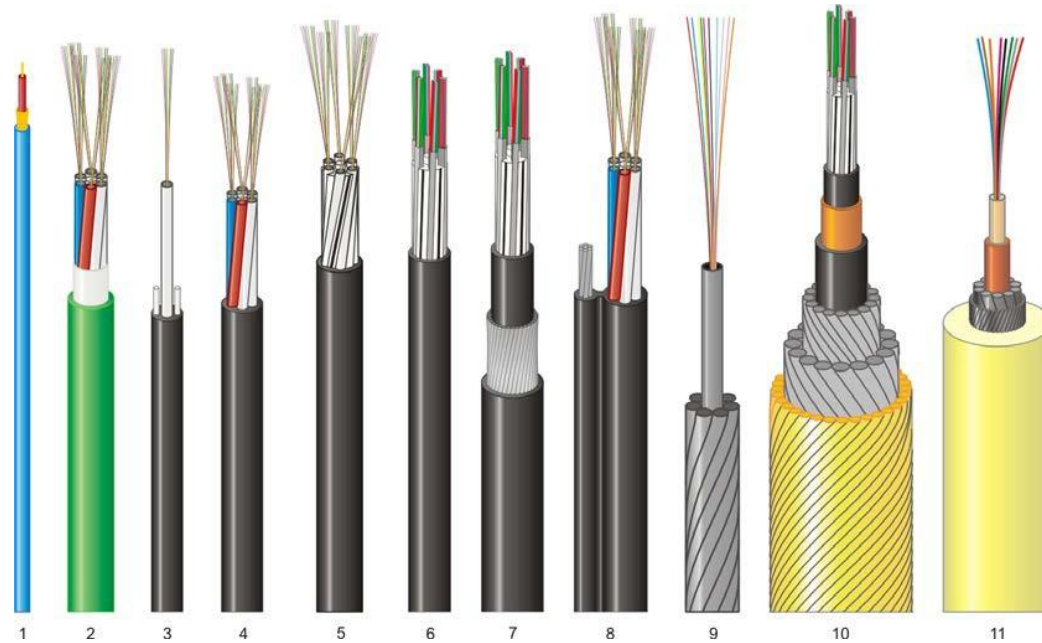


Image showing the structure of fibre optic cables G.652 and G.657.

Fibre optic cable with G.652 fibres is used in most standard cables. Fibre optic cables with fibres of typ G.657 are less bend-sensitive and are used primarily in access networks to individual customers.

Below are examples of various types of fibre optic cables.



*Examples of various fibre optic cables*

1. Patch cables, fitted with connectors at either end and normally used to connect networks to networks or active equipment to networks, usually between ODFs in ODF racks.
2. Concentric cable with fibres in duct. The cable is used to build networks in ducts or in a protected environment, e.g., indoors, in tunnels, within industrial buildings, etc. The green colour indicates that the cable is flame-retardant. This is not a standard colour for this purpose, although it has become a de facto standard.
3. Thin cable for outdoor application. Loose fibres or fibre ribbons centrally located in a grease-filled duct or cavity. Two thin strain relief devices are located on either side of the cable.
4. A very common cable. It must be routed in standard ducts. Between 4 and 16 secondary ducts containing loose fibres (normally 24 fibres in each duct) are cabled around a central strain relief device. The cavity between duct and duct and outer sheath is filled with filler to make the cable longitudinally watertight. This applies to all cables 4–11.
5. Cable with slotted core profile, in whose slots tubes with fibres are placed. The cable is considerably more resistant to radial pressure than those that are only cabled concentrically.
6. The same type of cable as before, but instead of secondary tubes there are fibre ribbons in the slots. This type of cable is used primarily in sections with a considerable demand for fibre. Fibre ribbons can be spliced considerably faster than individual fibres.
7. Here, cable number 6 has been supplied with robust reinforcement for burying or ploughing directly. The reinforcement comprises steel or aluminium wires.

8. Cable with integrated catenary for suspending between poles (telecom poles), with the max. span restricted to 50 metres. This model is generally referred to as a “figure of 8 cable”.
9. The earth wire at the top of the lattice structure for high-voltage cables can be supplied with optical fibre. This type of cable is known as OPGW cable, as it is intended to connect the lattices to each other and to earth.
10. Underwater cables for coastal installations with a need for many non-reinforced fibres and with limited routing depth. Can be supplied with erbium-doped fibre amplifier, which is why the distance between transmitter and receiver can be in excess of 300 km. The heavy reinforcement with steel wire means that the cable is strong in relation to lighter anchors, as well as providing the weight to follow the contours of the sea-bed. Fibres of the type ITU-T G.655 may be appropriate.
11. Cable for ocean routing, where the routing depth can be up to 8–10 km. The extremely long routing distances mean that amplifiers are used. These are supplied with power through the inner copper duct. The fibre that is used is often ITU-T G.654 with extremely low attenuation.



*Examples of micro-cables*

1. An alternative to “blown fibre” is this 1.2 mm thick cable, which is used for blowing to individual end users.
2. Thin micro-cable with the fibres in a grease-filled tube surrounded by aramid yarn as strain relief. On the outside of the aramid yarn is a sheath made of flame-retardant polyethylene, FRPE.
3. This picture shows an unusual 48-fibre cable where the fibres are bundled in 12-fibre strands (bundles). The strands are identified through different coloured yarn that has been wound around each strand. All the strands are placed in a grease-filled plastic tube, which in turn is surrounded by aramid yarn as strain relief and an external flame-retardant sheath made of halogen-free PE.



4. Micro-cable with the same structure as a standard cable for routing in standard ducts. This picture shows a cable where each grease-filled tube has the same diameter as the centrally located strain relief device, resulting in six surrounding tube. The standard design is for each tube to contain 12 fibres, which is why the pictured cable contains 72 fibres. The number of fibres in each tube can be doubled.
5. In this cable, the central strain relief device has been made slightly thicker than the surrounding tube. In this case, it has been adapted for eight surrounding tube, producing a cable with 96 fibres. If the number of fibres in each tube is doubled, this produces a 192-fibre cable.
6. Same design as in the two previous cables but has a few plastic strands placed between the secondary tube to make a more circular cable.

Fibres in a fibre optic cable that are connected at both ends are known as fibre links. A fibre link starts and ends in a node, a connection point (at a customer) or a distribution point (connecting point), normally an ODF (Optical Distribution Frame). Each end of the fibre link is connected to an outlet installed in an ODF unit. The ODF is mounted in a rack or in a small box at a customer.

A connection comprises a fibre link, or two or more fibre links that are connected together (cross-connected).

#### 2.4.2 Fibre optic cables for underground routing

##### MINIMUM REQUIREMENTS REGARDING FIBRE OPTIC CABLES TO BE ROUTED IN THE GROUND

- Fibre optic cables must be routed in ducts.
- The fibre optic cable must be approved for routing in ducts outdoors.
- The fibre optic cable must be executed with an identification system for the identification of individual fibres, e.g., through colour marking.
- The fibre optic cable must be longitudinally watertight.
- The fibre optic cable must be halogen-free.

#### 2.4.3 Fibre optic cables, cable gutters and cable ladders for indoor routing

##### MINIMUM REQUIREMENTS FOR FIBRE OPTIC CABLES FOR INDOOR ROUTING:

- Ducts and fibre optic cables intended solely for outdoor use may not extend by more than 20 m into a building and must remain within the same fire cell, according to Boverket's (National Board of Housing, Building and Planning) CPR class Dca-s2, d2, a2, valid from 2017. After this, ducts and fibre optic cables classified for indoor use must be used.
- Cable gutters and cable ladders can be designed according to SS-EN 61537. Cable rails can be designed according to SS-EN 61534 series. Suspension devices in escape routes must be designed in material class A2-sl, do. (BSF 2018: 4)

**2.4.4 Minimum requirements for pole routing**

From a robustness perspective, routing on poles should be avoided.

Fibre optic cables of the following types are available for pole routing:

- wrapping around power lines
- integrated in earth wire (OPGW)
- suspended from catenary (figure of 8)
- with integrated catenary, which is self-supporting (ADSS)
- in microducts for pole routing.

**MINIMUM REQUIREMENTS REGARDING FIBRE OPTIC CABLES WHEN ROUTING ON POLES**

- If fibre optic cables are being routed on poles, this must be carried out with cables and attachments that are adapted according to the routing method.
- The pole owner's rules and instruction will apply and may vary depending on local regulations, the use of the pole route (electricity, telecommunications), etc.

**2.4.5 Fibre optic cables for routing in water**

Important parameters when routing fibre optic cable in water are water depth, presence of maritime traffic, anchoring, fishing, etc. See more under "Routing in lakes or watercourses".

**MINIMUM REQUIREMENTS REGARDING FIBRE OPTIC CABLES FOR ROUTING IN WATER:**

- Routing must take place using fibre optic cables that are adapted for routing in water.
- The fibre optic cable must be longitudinally watertight.

**2.4.6 Fibre optic cables for routing in tunnels and culverts****MINIMUM REQUIREMENTS REGARDING FIBRE OPTIC CABLES WHEN ROUTING IN TUNNELS AND CULVERTS**

- In culverts, road, rail and pedestrian tunnels, the fibre optic cable must be halogen-free and self-extinguishing.
- If there is a risk of unauthorised entry, vandalism or pests, armoured fibre optic cables or ducts must be used.

## 2.5 Cable management

### 2.5.1 General requirements

In general, during all routing of fibre optic cable, pulling/blowing/floating must take place in a controlled manner with regard to tensile forces and bend radii, in accordance with the cable manufacturer’s instructions and using equipment intended for the purpose.

#### MINIMUM REQUIREMENTS HANDLING FIBRE OPTIC CABLE:

- Do not go below minimum permitted bend radius.
- Do not exceed maximum permitted tensile force.
- Do not exceed maximum permitted mechanical pressure.
- The ends of all non-connected cables must be sealed.
- The cable may not be handled at temperatures below that which has been specified. This means that, in certain cases, the drum has to remain in heated premises for some 24 hours before it can be transported. During transport, it should be covered so that the cable does not cool down.
- The laying of loops in the distribution points or optical fibre chambers shall be based on an assessment of future ground works, for example on larger groundworks, roads and in the vicinity of urban areas where settlements may take place.
- Loops, placement, length and documentation should be done according to the recommendations of the network owner.
- Loop must always be routed in optical fibre chambers, regardless of fibre optic cable type.
- Cable drums with fibre optic cable must be handled upright.
- The cable’s flushing direction is marked on the cable drum and must be followed.
- When blowing micro-cable, a compressor with a moisture separator and the correct filter according to the compressor manufacturer must be used.

Cable dimensions: This table shows suitable matching for the dimension of fibre optic cable with suitable duct.

| Cable outer diameter | Microduct with inner diameter |     |     |     |   |    | Standard duct with inner diameter |    |    |    |    |    |    |    |
|----------------------|-------------------------------|-----|-----|-----|---|----|-----------------------------------|----|----|----|----|----|----|----|
|                      | 2.1                           | 2.8 | 3.5 | 5.5 | 8 | 10 | 12                                | 14 | 16 | 20 | 26 | 28 | 32 | 40 |
| 1.2                  | ✓                             |     |     |     |   |    |                                   |    |    |    |    |    |    |    |
| 1.8                  |                               | ✓   |     |     |   |    |                                   |    |    |    |    |    |    |    |
| 2.4                  |                               |     | ✓   |     |   |    |                                   |    |    |    |    |    |    |    |
| 3.9                  |                               |     |     | ✓   |   |    |                                   |    |    |    |    |    |    |    |
| 4.0                  |                               |     |     |     | ✓ |    |                                   |    |    |    |    |    |    |    |
| 5.4                  |                               |     |     |     |   | ✓  |                                   |    |    |    |    |    |    |    |
| 6.2                  |                               |     |     |     |   |    | ✓                                 |    |    |    |    |    |    |    |
| 6.4                  |                               |     |     |     |   |    |                                   | ✓  |    |    |    |    |    |    |
| 6.8                  |                               |     |     |     |   |    |                                   |    | ✓  |    |    |    |    |    |
| 7.5                  |                               |     |     |     |   |    |                                   |    |    | ✓  |    |    |    |    |
| 8.5                  |                               |     |     |     |   |    |                                   |    |    |    | ✓  |    |    |    |
| 9                    |                               |     |     |     |   |    |                                   |    |    |    |    | ✓  |    |    |
| 10                   |                               |     |     |     |   |    |                                   |    |    |    |    |    | ✓  |    |
| 11                   |                               |     |     |     |   |    |                                   |    |    |    |    |    |    | ✓  |
| 12                   |                               |     |     |     |   |    |                                   |    |    |    |    |    |    |    |
| 13                   |                               |     |     |     |   |    |                                   |    |    |    |    |    |    |    |
| 14                   |                               |     |     |     |   |    |                                   |    |    |    |    |    |    |    |
| 15                   |                               |     |     |     |   |    |                                   |    |    |    |    |    |    |    |
| 16                   |                               |     |     |     |   |    |                                   |    |    |    |    |    |    |    |
| 17                   |                               |     |     |     |   |    |                                   |    |    |    |    |    |    |    |
| 18                   |                               |     |     |     |   |    |                                   |    |    |    |    |    |    |    |
| 19                   |                               |     |     |     |   |    |                                   |    |    |    |    |    |    |    |
| 20                   |                               |     |     |     |   |    |                                   |    |    |    |    |    |    |    |
| 21                   |                               |     |     |     |   |    |                                   |    |    |    |    |    |    |    |
| 22                   |                               |     |     |     |   |    |                                   |    |    |    |    |    |    |    |
| 23                   |                               |     |     |     |   |    |                                   |    |    |    |    |    |    |    |
| 24                   |                               |     |     |     |   |    |                                   |    |    |    |    |    |    |    |
| 25                   |                               |     |     |     |   |    |                                   |    |    |    |    |    |    |    |

### 2.5.2 Routing fibre optic cable in optical fibre chambers and cabinets

In order to position the fibre optic cable correctly in the optical fibre chamber or outdoor splice cabinet where a loop is to be created, careful preparation and handling are required. The cable's properties are changed if the cable is twisted, and this can easily happen during looping if this is not done correctly. Comply with the cable manufacturers instructions regarding looping. For example, some cable types may need to be looped in the form of a figure of eight. Checking whether the fibre optic cable is twisted can be performed by inspecting that the cable's longitudinal labelling is in the same direction. A cable length of approx. 20 metres is suitable as a loop length.

Micro-cable can be looped in the same way as standard cable. However, micro-cable is not as robust in the structure as standard cable, and extra care must therefore be taken when handling micro-cable.

#### MINIMUM REQUIREMENTS WHEN ROUTING FIBRE OPTIC CABLE IN OPTICAL FIBRE CHAMBERS AND OUTDOOR SPLICE CABINETS:

- The cable manufacturer's instructions regarding looping must be complied with.
- If individual fibres, fibre units, fibre ribbons or bundled fibres are used, these must never be looped freely in optical fibre chambers as there is a risk of fibre breaks and moisture damage. They must be looped in a splicing box.
- All fibre-optic cables for outdoor use must be able to cope with lying in water.

### 2.5.3 Routing fibre optic cable indoors

Where fibre optic cables are routed in public areas such as cellars, garages, etc., and there is a risk of unauthorised entry, vandalism or sabotage, security must be improved by the cables being routed as well concealed as possible using mechanical protection.

#### MINIMUM REQUIREMENTS WHEN ROUTING FIBRE OPTIC CABLE INDOORS:

- When there is a risk of unauthorised entry, vandalism or sabotage, indoor fibre optic cables must be protected mechanically with ducts or equivalent.

### 2.5.4 Splicing cables

#### MINIMUM REQUIREMENTS WHEN SPLICING FIBRE OPTIC CABLE:

- The fibres in the cable must be spliced by means of welding.
- The fibre splice must be protected in a splicing sleeve. The spliced fibres must then be placed in one or more fibre cassettes, which in turn must be protected by a splicing cabinet or splicing box.
- Do not go below the fibres' minimum bend radius. See the cable manufacturer's specification.
- The strain on the fibre optic cables must be relieved in a splicing box or splicing cabinet using integral strain relief for the cable in question, e.g., glass fibre rod or aramid yarn.

As far as possible, avoid a network design where splicing takes place in connectors. Connectors always produce more attenuation and reflection, which can affect the signal.

### 2.5.5 Splicing units

The fibre optic cable's splice is protected in a splicing unit. Splicing units in the form of splice boxes or splice cabinets are selected according to the environment in which they are placed, the number of fibres to be spliced, as well as the cables and any microducts that are to be connected.

Splice boxes are normally intended for direct routing in the ground or optical fibre chambers.

Splice cabinets are available for installation outdoors in an outdoor splice cabinet and for installation in an indoor environment.

A wall box for outdoor use is a splice cabinet and outdoor splice cabinet in one unit.

A facade box is a box located on the facade of a house and used for splicing fibre optic cable for the house.

Splice units can also include intermediate pieces and connectors.

#### MINIMUM REQUIREMENTS FOR SPLICING UNITS:

- Always follow the manufacturer's instructions regarding temperature, pressure sealing, strain relief, cable twist, bend radii, splice holders, etc.
- Splice unit located below ground level shall meet rating IP68.
- Splice unit located above ground level, without additional enclosure, should meet at least IP54.
- Splice unit located outdoors, without additional enclosure, should be UV resistant.
- Splice unit placed accessible to the public should be in class at least IK 8 and be able to be locked.
- Splice unit located above ground level with an IP rating lower than IP54, should be enclosed by external enclosure that meets at least a rating of IP34.
- Ensure that the sealing of the splice unit is sufficient, for example regarding pests and water penetration, for the environment in which the splice unit is located.
- Splice unit - Facade box placed accessible to the public should be at least class IK 7 and should not be able to be opened without tools.

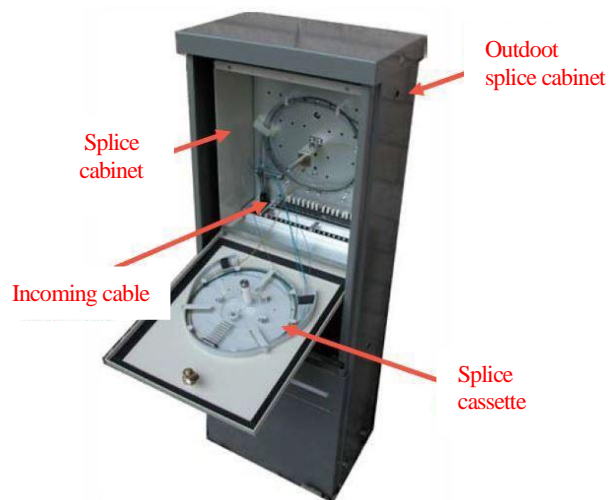


*Example of facade boxes*

### MINIMUM REQUIREMENTS REGARDING SPLICING CABINETS:

- Splice cabinets for outdoor routing above ground must be surrounded with an external enclosure that satisfies at least classification IP34. Ensure that the sealing of the splice cabinet is enough, eg. in respect of pests and water penetration, for the environment where the splice cabinet is located.
- When outdoors, splice cabinets must be installed in an outdoor splice cabinet or equivalent enclosure.
- Splice cabinets must be UV-resistant.
- Splice cabinets that are positioned so that they are accessible to the general public must be class IK 8.

*Example of outdoor splice cabinet for outdoor use with splicing unit*



*Example of outdoor splice cabinet with splicing cabinet and splice cassette*

### 2.5.6 Termination of cable in node

Termination means that the fibres in a fibre optic cable are made accessible via connectors in a connection panel. The connection panel is part of an ODF (Optical Distribution Frame).

Fibre optic cable classified for outdoor use must be re-spliced (transition joint or station joint) to fibre optic cables for indoor use if the indoor section exceeds 5 m, see point 2.4.3.

Transition joints are normally located outdoors in an intake chamber or outdoor splice cabinet.

Pre-connected indoor cable (known as stub cable) is often used from ODF to transition joint.

The indoor cable is terminated with optical connectors on the inside (line side) in an ODF unit. The fibres are thereby accessible for cross-connection or connection of active communication equipment on the front (connection panel) of the ODF unit.

#### 2.5.6.1 ODF (Optical Distribution Frame)

In an ODF unit, the fibre optic cable is welded to preconnected pigtailed or preconnected fan-outs. On the ODF unit's panel (front), intermediate pieces are installed where the connectors are connected. In this way, the fibres are made accessible for connection in connectors, for connecting equipment or cross-connection.

An ODF unit is often 19 inches wide and its height can range from 1U (height unit) up to 3U. An ODF can comprise everything from an individual ODF unit with a small number of connectors to covering many units in several racks where all fibre optic cables in the node are terminated.

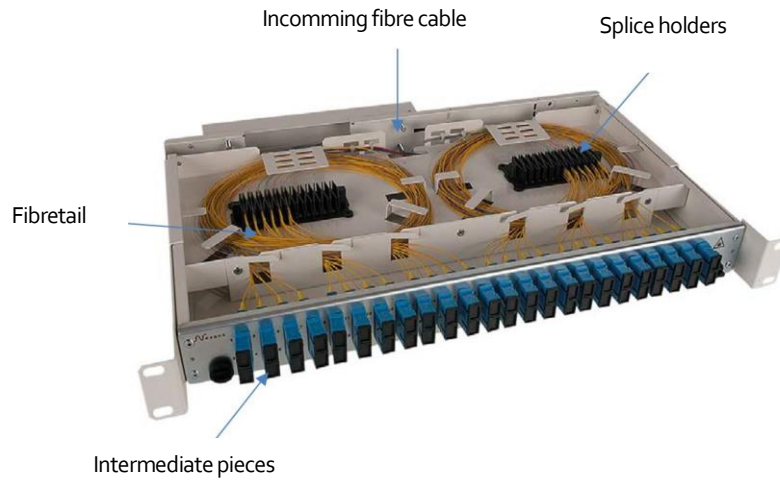
When selecting equipment for an ODF, certain basic functions as shown below must be satisfied to achieve a robust network.

#### MINIMUM REQUIREMENTS REGARDING ODF UNIT:

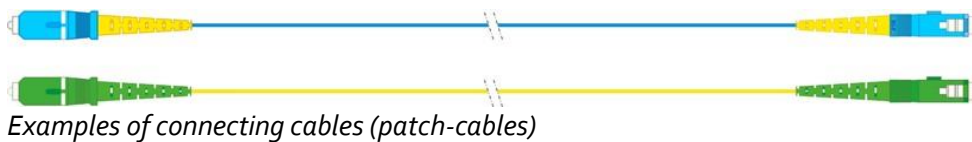
- The ODF unit must have protection in front of the connector panel.
- It must be easy to access the inner connectors for cleaning or replacing intermediate pieces, e.g., via a removable or swivelling front panel.
- The empty intermediate pieces, where no connector is installed, must be supplied with dust protection both inside the ODF unit and on the panel.
- Green intermediate pieces must never be used together with blue connectors or vice versa.

#### Recommendation

Different solutions and models in the same stand should be avoided as they can prevent work in the unit above or below.



Example of ODF unit



Examples of connecting cables (patch-cables)

#### MINIMUM REQUIREMENTS REGARDING ODF RACK:

- ODF units with stub cable (prefabricated unit with connectors and fibre optic cable of various lengths) must be able to be installed in the rack. The stub cable is routed from the ODF rack, e.g., on cable ladders, up to a transition joint where it is welded to the incoming fibre optic cable.
- ODF racks must be placed so that incoming fibre optic cables that are routed indoors can be spliced directly inside the ODF unit.
- ODF racks must be designed so that future operational and maintenance work can easily be carried out, e.g., replacement, repair and supplementing in the ODF units.
- Cable routes must be present, and all connection cables must be located in cable holders. This requirement applies to the entire ODF, i.e. in panels within the same rack and between racks.
- ODF racks must be designed so that the handling of connection and connecting cables is rational in respect of radius restriction, order, excess length, quantity, switching, supplementing, etc.
- ODF racks must be designed so that cross-connection can take place within the same ODF rack or via designated transfer routes to another ODF rack or to racks with active equipment.

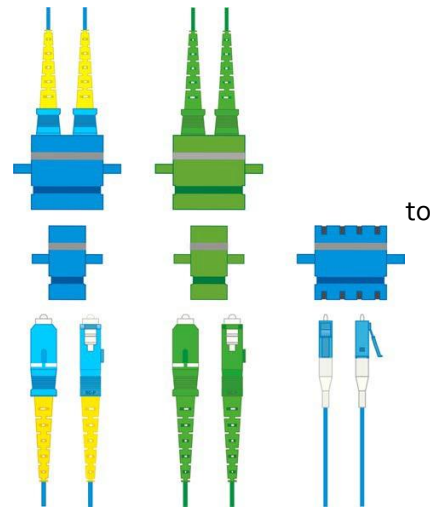
#### 2.5.7 Optical connectors and cleaning



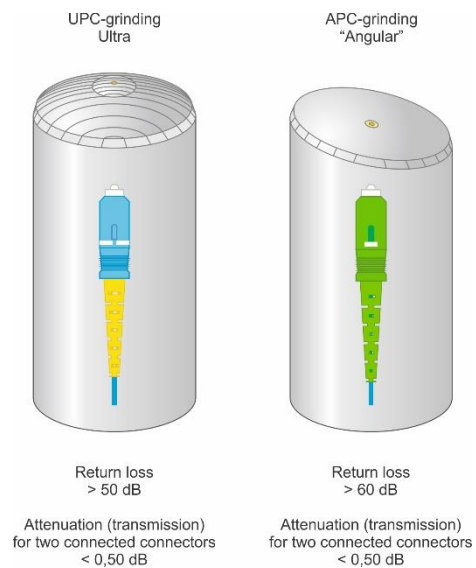
2.5.7.1 Optical connectors

There are several types of optical connectors. The most common connector types in broadband networks are LC (Lucent Connector) and SC (Subscriber or Standard Connector). In order to connect two connectors to each other, an intermediate piece is used.

The colour of the connectors describes the type of polishing used on the connector’s end surface. The most common are UPC (blue, spherical polishing) or APC (green, 8° angled polishing). UPC is most common in broadband networks. APC is mostly used in cable TV networks, where it is important for the reflection of light be minimised (high reflection attenuation).



Examples of optical connectors and intermediate pieces. From the left: SC connector UPC, SC connector APC, LC connector UPC with intermediate pieces.



Different polishing of the connector ferrule. Specified attenuation values are quality parameters.

2.5.7.2 Cleaning

Optical connectors and intermediate pieces are normally only cleaned using dry methods (e.g., cleaning box/card and stylus/pen).

In exceptional cases, i.e. in the event of heavily soiled connectors, connectors can be cleaned using isopropanol. When cleaning with isopropanol, the connector must be dried immediately by cleaning using a dry method.



*Cleaning fibre with cleaning cassette*

**2.5.8 Termination outdoors**

ODF units or equipment open panels are not used outdoors in outdoor splice cabinets to create switch points, as this requires entirely sealed boxes.

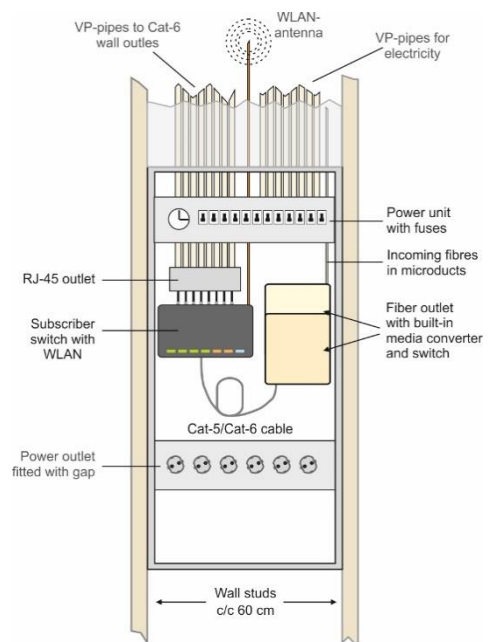
If switch points with optical connectors are placed out in the network, these should be located indoors or in special outdoor cabinets (environmental cabinets).

**2.5.9 Termination in house**

A house refers to a villa or terraced house as an individual dwelling. For the connection of apartment buildings, residential, commercial premises, office premises see recommendation "Robusta fastighetsnät".

After a fibre optic cable has been routed into a house, a seal is installed between duct and fibre optic cable.

Incoming fibre optic cables into houses are terminated in a fibre outlet alternatively a Facade box. Fiber outlets should be located in the immediate vicinity of a cable intake in the wall or in a "broadband space" in order to create a flexible connection point. From the outlet, a connection cable that is robust and adapted for installation is routed into the house to the active customer equipment.



*Example of broadband space combined with distribution board in a house*

**MINIMUM REQUIREMENTS FOR TERMINATION IN A HOUSE:**

- An incoming cable entering a house must be terminated in a standalone fibre outlet alternatively Facade box.  
Standalone also means a unit/plate on which a switch is installed and there is a separate space for fibre on the unit/plate.
- A separate CPE should be provided with the warning sign "Laser Warning"

### 2.5.9.1 Fibre outlet

The fibre outlet in a house is the property of the network owner. The fibre outlet should be designed so that the connector on a connected connection cable is not too visible and easily accessible.

A customer with the technical knowledge and a set of instructions should be able to disconnect and replace the patch cable without opening the fibre outlet. The patch cable must be in a robust version that is adapted for the purpose.

### MINIMUM REQUIREMENTS FOR FIBRE OUTLETS IN A HOUSE:

- An outlet installed directly on a wall must be angled down, parallel with the wall.
- The intermediate piece must be physically protected against dust, even if the connector is removed.
- Fibre outlets in houses must be marked with the symbol "Laser warning" in accordance with section 2.6.5 Fiber outlet.
- When installing fibre outlets, the customer's alt. the manufacturer's instructions are followed.

### 2.5.10 Optical radiation

Optical radiation is principally a safety issue for those who handle optical connectors and cabling. Do not look into connectors if these are connected to a laser.



Laser radiation can damage vision. As the light may be invisible, warning labels must be present by fibre outlets to call attention to and warn about these risks. The invisible light does not trigger a blink reflect, which would protect the eye.

### 2.5.11 Delivery measurement of fibre connections

After installation, delivery measurement is conducted at the installation and a measurement report is prepared. Delivery measurement of fibre optic cables is performed to ensure that the physical installation and the documentation correspond, and to verify that minimum requirements in respect of e.g., attenuation are satisfied. An Excel calculation is available as an aid. See sub-appendix 2.1 Calculating attenuation.

#### 2.5.11.1 Measurement methods

There are two common measurement methods for delivery measurement of newly installed fibre optic cables:

- Attenuation measurement, dB measurement
- OTDR measurement.

#### For Robust Fibre, OTDR measurement applies.

During OTDR measurement, an optical reflectometer is used (OTDR = Optical Time Domain Reflectometer). OTDR transmits a pulse of light, which is reflected in inhomogeneities, joints, connectors and end points.

OTDR is used to measure e.g., attenuation and connector reflections. OTDR is also used to find attenuation increases, e.g., in poor splices, pinching or defective cables. Always follow

the instrument manufacturer's instructions in respect of executing measurement.

#### 2.5.11.2 Choice of OTDR instrument

The instrument's performance is selected on the basis of the type of connection being measured.

An OTDR instrument that is used in national networks can measure long distances with a high degree of accuracy, while an OTDR instrument that is used in connection networks requires a good resolution over short distance.

#### 2.5.11.3 If a defective fibre optic cable is suspected

If it is suspected that the fibre optic cable has been subjected to external influences in conjunction with installation, e.g., damaged cable drum, pinching, etc., the fibres must be checked using one of the listed measurement methods.

### 2.5.12 Delivery measurement of passive fibre

#### MINIMUM REQUIREMENTS IN RESPECT OF DELIVERY MEASUREMENT OF PASSIVE FIBRE:

- Unidirectional OTDR measurement must be performed between the endpoints on all connections at 1310 nm and 1550 nm.
- One-way OTDR measurement should also be performed where there is only one contacted end.
- If the incoming optical fiber to a house is terminated in a fiber outlet or in a facade box, it forms the end point of the connection. For termination in apartment buildings, see recommendation "Robusta fastighetsnät".
- The measuring instruments must be calibrated in accordance with the manufacturer's procedures.
- The measurement report must specify the measuring instrument, OTDR settings (measurement area, pulse, time and index of refraction (IOR)), as well as who has carried out the measurement.
- The measurement results from OTDR-measurements and OTDR measurements must be saved in original file format, e.g., .sor/trc/.msor.
- The limit values according to table 2.5.12.1 must not be exceeded.
- In OTDR measurement, the following shall:
  - the pulse width should always be as short as possible, however, the entire graph should always be able to be read without noise.
  - the measuring window is always set so that the entire curve is visible in the window, e.g. the distance is 3 km, the measurement window is set to the closest longer distance range.
  - Launch Cable is always used. The length should be adjusted taking into account the so-called "dead zone" in order to be able to measure the first contact.
  - correct time and date must be set.

Note:

If several cables to be spliced have different index of refraction, IOR, the network owner should specify the IOR to be used

#### 2.5.12.1 Measurement results and limit values for fibre in cables

Measured values in the chapter are based on current standards ITU-T-G.652–201611 and ITU-T-

G.657–201611.

Table: Minimum limit values for fibre in cables (summary table)

| Limit value for attenuation in routed optical fiber  |                |
|--|----------------|
| Limit value at 1310 nm   | Max 0,40 dB/km |
| Limit value at 1550 nm   | Max 0,30 dB/km |
| Limit value at 1625 nm*1   | Max 0,40 dB/km |
| Spot attenuation change at 1550 nm or 1625 nm. Spot attenuation change refers to "spikes" greater than 0,05 dB.        | 0,05 dB        |
| Fibre attenuation may at most exceed the factory measurement of the fibre by 0,03 dB/km vid 1310/(1550 or 1625) nm.    |                |
| Average valaue refers to the combined value of all the fibres in a section of cable                                    |                |
| Limit value at individual splice   |                |
| Max limit value, access network (<10 km)   | 0,25 dB        |
| Limit value at connector   |                |
| Attenuation per interconnected connector   | 0,5 dB         |
| Reflection attenuation UPC (ultra-polished connector)  | min 50 dB      |
| Reflection attenuation APC (angular-polished connector)  | Min 60 dB      |
| *1) When measuring activ access connection with filtered wavelength 1625 nm to single dwelling unit (SDU) connections. |                |

**MINIMUM REQUIREMENTS regarding measurement results for access networks:**

The value obtained for attenuation must be below the following theoretical calculation:

At 1310 nm: length x 0.40 + splice x 0.25 + 1.0 + 0.5 dB

At 1550 nm: length x 0,30 + splice x 0.25 + 1.0 + 0.5 dB

**Explanation of the above abbreviations:**

**length** = optical length (km) **splice** = number of splices

**1.0 dB** relates to losses in event of connection to ODF, 2x if 0.5 dB (including first splice after ODF)

**0.5 dB** estimated value to the combined measurement uncertainty in instruments with connectors.

As support for calculating the connection attenuation, an Excel calculation has been produced that can be downloaded from robustfibre.se under Instructions.

**Note:** Check the network owner's requirements before measuring.

**2.5.13 Delivery measurement of active fibre**

Active fibre refers to a connection that has an active CPE/Switch that signals at 1310 nm and 1550 nm on the fibre. Delivery measurement can then be conducted with a filtered wavelength of 1625 nm.

Active measurement assumes that measurement is from one direction only.

**MINIMUM REQUIREMENTS IN RESPECT OF DELIVERY MEASUREMENT OF ACTIVE FIBRE:**

- Unidirectional OTDR measurement must be performed at 1625 alt. 1650 nm on active fibre connection. The measuring instruments must be calibrated in accordance with the manufacturer’s procedures.
- OTDR measurement must be done according to the instrument manufacturer's instructions.
- The measurement report must specify the measuring instrument, OTDR settings (measurement area, pulse, time and index of refraction (IoR)), as well as who has carried out the measurement.
- The measurement results from attenuation measurements and OTDR measurements must be saved in a generally legible file format, e.g., Excel, .pdf or .sor for OTDR.
- The limit values according to table 2.5.12.1 must not be exceeded.
- Delivery measurement for an active fibre connection may only be used for single dwelling unit (SDU) connections.

### 2.5.13.1 Measurement results and limit values for fibre in cables

See Table 2.5.12.1 for minimum limit values for fibre in cables (summary table).

The following requirements regarding fibre in cables constitute input data during delivery measurement of an installed system.

#### **MINIMUM REQUIREMENTS regarding measurement results for access networks:**

The value obtained for attenuation must be below the following theoretical calculation:

At 1625 nm:  $\text{length} \times 0.40 + \text{splice} \times 0.25 + 1.0 + 0.5 \text{ dB}$

#### **Explanation of the above abbreviations:**

**length** = optical length (km) **splice** = number of splices

**1.0 dB** relates to losses in event of connection to ODF, 2x if 0.5 dB (including first splice after ODF)

**0.5 dB** estimated value to the combined measurement uncertainty in instruments with connectors

## 2.6 Labelling

The fibre installation must be labelled in a uniform manner.

#### **MINIMUM REQUIREMENTS IN RESPECT OF LABELLING OF THE FIBRE INSTALLATION:**

- All parts of the fibre installation must be labelled with unique designations.
- All labels must be adapted to existing environment. They must be age-resistant, UV resistant and be/exist in water for a long time. They must also withstand different types of liquids such as oil, benzene, alcohol, solvents etc.
- Labelling must correspond with the documentation's designation.
- Labelling must not contain plain text for security reasons, e.g., "Arboga-Köping" or the customer's name,
- The labelling must be scratch-proof.

### 2.6.1 Labelling and designation of ducts

#### **MINIMUM REQUIREMENTS IN RESPECT OF LABELLING AND DESIGNATION OF DUCTS:**

- When routing several ducts in the same trench, the ducts must be supplemented with various longitudinal colour markings or other weather and ageing-resistant labelling systems, in order to facilitate identification and documentation so as to avoid confusion.
- Any sub-duct must be supplied with an identification system for identifying individual ducts, e.g., colour marking.
- Ducts must be labelled at both inputs and outputs in optical fibre chambers and cabinets, at transitions from e.g., mast to cable ladder, as well as on either side of wall bushings.
- Ducts must be labelled at both inputs and outputs in wall bushings when connecting a building/property. Exceptions may be made if the duct is present for an individual customer connection, e.g., connection to a single dwelling unit.

Optical fibre chambers and cabinets are ideally labelled the door/hatch in order to prevent unauthorised parties seeing the labelling.



inside  
from

*Example of labelling of ducts*

## 2.6.2 Labelling cables

### MINIMUM REQUIREMENTS IN RESPECT OF LABELLING OF CABLES:

- Fibre optic cables must be labelled at both inputs and outputs in optical fibre chambers and cabinets, at transitions from e.g., mast to cable ladder, as well as on either side of wall bushings.



*Example of labelling of fibre optic cable*

### MINIMUM REQUIREMENTS FOR THE MARKING OF CABLE/BLOWN FIBRES FOR HOUSE:

A cable/blown fiber to an individual user shall be identified via ducting color coding or by other agreed means.



### 2.6.3 Numbering and labelling of racks and panels

Rack numbering starts from the left-hand corner, viewed from the input (applies in smaller nodes). In large nodes, a site drawing must be created that shows the location and numbering of the racks.

A panel, e.g., an ODF unit, which is installed in a rack, will be designated according to where the upper left corner is positioned in relation to the layout of the rack.

Numbering of outlets in a panel must start from the upper left corner in each panel. Work on the basis of the manufacturer's label, if present. If there is no label, outlets must be numbered consecutively, e.g., 01, 02, 03, etc.

#### MINIMUM REQUIREMENTS REGARDING LABELLING OF RACKS AND PANELS:

- Each rack must be labelled with a unique designation.
- Each individual ODF unit must be labelled.
- The outlets' numbering must be labelled on the panel.

### 2.6.4 Splicing units

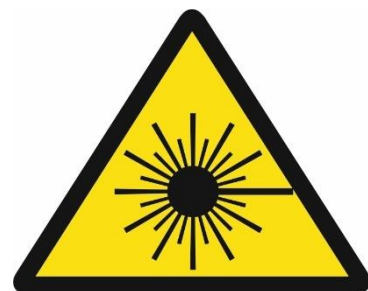
#### MINIMUM REQUIREMENTS REGARDING LABELLING OF SPLICING UNITS:

- On a splice cassette it must be clear which fibres / cables are in the cassette.
- Markings should not be included, for example, with covers or faceplates when they are removed.
- In the case of exposed fibre connectors, there should be a clear marking with "Warning for laser".

### 2.6.5 Fibre outlets

#### MINIMUM REQUIREMENTS FOR LABELLING FIBRE OUTLETS IN HOUSES:

- Fibre outlets in houses must be labelled with the "Warning: laser" symbol.



## 2.7 Safety

### 2.7.1 Locks

A distribution point may be designed in many different ways. A common feature of all types of distribution points is that they are locked with a key, card or similar system, so that unauthorised parties cannot enter the area. This consequently applies to nodes, optical fibre chambers, outdoor splice cabinets and splicing boxes, as well as other areas where there is access to end points or splices.



As regards optical fibre chambers, there are a great many different types of locks, e.g., lockable inner hatches or specific “opening tools”. If an optical fibre chamber is placed below ground level, i.e. with Selected Sandfill above the optical fibre chamber cap, no locking device is required.

Locks such as “single-track”, which can be opened with a chisel, or “triangle” locks are not approved from a robustness perspective.

#### MINIMUM REQUIREMENTS IN RESPECT OF LOCKING:

- Distribution points must be locked with an approved key, card or in a similar manner.

Below are examples of locks that are approved:

- EBR lock or “Stockholm lock”.
- Padlock with key.
- Cylinder lock.
- Penta-head lock.





*Examples of locks*